

Part No. 060196-10, Rev. G
June 2007

OmniSwitch 6800 Series Hardware Users Guide

Alcatel-Lucent 

www.alcatel-lucent.com

This user guide documents OmniSwitch 6800 Series hardware, including chassis and associated components.
The specifications described in this guide are subject to change without notice.

Copyright © 2007 by Alcatel-Lucent. All rights reserved. This document may not be reproduced in whole or in part without the express written permission of Alcatel-Lucent.

Alcatel-Lucent® and the Alcatel-Lucent logo are registered trademarks of Alcatel-Lucent. Xylan®, OmniSwitch®, OmniStack®, and Alcatel-Lucent OmniVista® are registered trademarks of Alcatel-Lucent.

OmniAccess™, Omni Switch/Router™, PolicyView™, RouterView™, SwitchManager™, VoiceView™, WebView™, X-Cell™, X-Vision™, and the Xylan logo are trademarks of Alcatel-Lucent.

This OmniSwitch product contains components which may be covered by one or more of the following U.S. Patents:

- U.S. Patent No. 6,339,830
- U.S. Patent No. 6,070,243
- U.S. Patent No. 6,061,368
- U.S. Patent No. 5,394,402
- U.S. Patent No. 6,047,024
- U.S. Patent No. 6,314,106
- U.S. Patent No. 6,542,507



**26801 West Agoura Road
Calabasas, CA 91301
(818) 880-3500 FAX (818) 880-3505
support@ind.alcatel.com
US Customer Support—(800) 995-2696
International Customer Support—(818) 878-4507
Internet—service.esd.alcatel-lucent.com**

Contents

	About This Guide	ix
	Supported Platforms	ix
	Who Should Read this Manual?	x
	When Should I Read this Manual?	x
	What is in this Manual?	x
	What is Not in this Manual?	x
	How is the Information Organized?	xi
	Documentation Roadmap	xi
	Related Documentation	xiii
	User Manual CD	xiv
	Technical Support	xiv
Chapter 1	OmniSwitch 6800 Series	1-1
	Stacked Configurations	1-3
	Availability Features	1-4
	Management Module Redundancy	1-4
	Software Rollback	1-5
	Backup Power Supplies	1-5
	Hot Swapping	1-5
	Hardware Monitoring	1-6
	Port and Fabric Capacities	1-7
	OmniSwitch 6800 Series Application Examples	1-8
	Gigabit-to-the-Desktop Migration	1-8
	Server Aggregation	1-9
	Layer 3 Aggregation/Distribution	1-10
	Small Enterprise Core	1-11
Chapter 2	OmniSwitch 6800 Series Chassis and Hardware Components	2-1
	OmniSwitch 6800-24	2-3
	OmniSwitch 6800-48	2-5
	OmniSwitch 6800-U24	2-7
	OmniSwitch 6800-24L	2-9
	OmniSwitch 6800-48L	2-11

Status LEDs	2-13
10/100/1000 LEDs	2-14
1000 SFP LEDs	2-14
10/100 LEDs	2-14
Rear Panel	2-15
Mounting the Switch	2-16
Airflow Considerations	2-16
Chassis Airflow	2-17
Blank Cover Panels	2-18
Installation Options	2-19
Installing the Switch on a Tabletop or Bench	2-19
Rack-Mounting the Switch	2-20
Installing and Removing Combo Port SFPs	2-21
Setting Up a Stacked Configuration	2-22
Rack Mounting Stacked Configurations	2-22
Cabling Stacked Configurations	2-22
Redundant Stacking Cable Connections	2-22
Supported Cabling Patterns	2-22
Booting OmniSwitch 6800 Series Switches	2-25
Booting a Stand-alone Switch	2-25
Booting Stacked Configurations	2-26
Power Cords	2-27
Console Port	2-28
Serial Connection Default Settings	2-28
Modifying the Serial Connection Settings	2-28
Console Port Pinouts	2-30
RJ-45 Console Port – Connector Pinout	2-30
Monitoring the Chassis	2-31
Checking Overall Chassis Status	2-31
Checking Temperature Status	2-31
Checking Fan Status	2-32
Checking Power Supply Status	2-32
Additional Monitoring Commands	2-32
Using LEDs to Visually Monitor the Chassis	2-33
OS6800-XNI-U2 10 Gigabit Expansion Module	2-34
10 Gigabit Slot and Port Numbering	2-35
10 Gigabit Expansion Modules and Token Usage	2-35
10 GigE Interoperability Between OS6800 and OS8800 Switches	2-36
Installing 10 Gigabit Expansion Modules	2-37
Removing 10 Gigabit Modules	2-38
Blank Cover Panel Requirement	2-38
Installing SFP and XFP Transceivers	2-39

Backup Power Supply Components	2-39
OS6800-BPS-SHLF Backup Power Supply Shelf	2-40
OS6800-BPS-SHLF Backup Power Shelf Specifications	2-41
OS6800-BPS-225 225W Backup Power Supply	2-42
OS6800-BPS-225 225W Backup Power Supply Specifications	2-43
Rack-Mounting the OS6800-BPS-SHLF Power Shelf	2-44
Installing a Backup Power Supply In the Power Shelf	2-46
Installing the Backup Power Supply Daughtercard	2-48
Installing the Backup Power Supply Connector Cables	2-48
Powering on the Backup Power Supplies	2-48
Removing a Backup Power Supply	2-49
Removing the Backup Power Supply Daughtercard	2-51
Blank Cover Panel Requirement	2-51
Backup Power Supply Pinouts	2-52
Viewing Primary and Backup Power Supply Status	2-53
Viewing Power Supply Status for Stacked Configurations	2-53
A Slot Number is Specified	2-53
No Slot Number is Specified	2-54
Chapter 3 Managing OmniSwitch 6800 Series Stacks	3-1
In This Chapter	3-1
OmniSwitch 6800 Series Stack Overview	3-2
Roles Within the Stack	3-2
Primary and Secondary Management Modules	3-2
Primary Management Module Selection	3-5
Secondary Management Module Selection	3-8
Idle Module Role	3-10
Pass-Through Mode	3-11
Recovering from Pass-Through Mode (Duplicate Slot Numbers)	3-12
Stack Cabling	3-15
Redundant Stacking Cable Connection	3-16
Checking Redundant Stacking Cable Status	3-17
Slot Numbering	3-18
Dynamic Slot Number Assignment	3-18
Manual Slot Number Assignment	3-20
Reverting to the Dynamic Slot Numbering Model	3-21
Hot-Swapping Modules In a Stack	3-22
Removing Switches from an Existing Stack	3-22
Inserting Switches Into an Existing Stack	3-22
Merging Stacks	3-23
Understanding Tokens	3-24
Checking Tokens Currently Used In a Stack	3-24

Reloading Switches	3-25
Reloading the Primary Management Module	3-25
Reloading the Secondary Management Module	3-27
Reloading Switches with Idle Roles	3-29
Reloading Switches in Pass-Through Mode	3-29
Reloading All Switches in a Stack	3-30
Software Synchronization During a Full Reload	3-30
Effects of Saved Slot Number Information on the Reload Process	3-30
Avoiding Split Stacks	3-32
Changing the Secondary Module to Primary	3-33
Synchronizing Switches in a Stack	3-35
Automatic Synchronization During a Full Reload	3-35
Monitoring the Stack	3-36
Visually Monitoring the Stack	3-36
CLI Commands Supported on Both Primary and Secondary Management Modules	3-37
Appendix A	
Regulatory Compliance and Safety Information	A-1
Declaration of Conformity: CE Mark	A-1
Waste Electrical and Electronic Equipment (WEEE) Statement	A-1
China RoHS: Hazardous Substance Table	A-2
Standards Compliance	A-4
FCC Class A, Part 15	A-5
Canada Class A Statement	A-5
JATE	A-5
CISPR22 Class A warning	A-5
VCCI	A-6
Class A Warning for Taiwan and Other Chinese Markets	A-6
Translated Safety Warnings	A-7
Chassis Lifting Warning	A-7
Blank Panels Warning	A-7
Electrical Storm Warning	A-7
Installation Warning	A-8
Invisible Laser Radiation Warning	A-8
Lithium Battery Warning	A-9
Operating Voltage Warning	A-9
Power Disconnection Warning	A-10
Proper Earthing Requirement Warning	A-10
Read Important Safety Information Warning	A-11
Restricted Access Location Warning	A-11
Wrist Strap Warning	A-12

Instrucciones de seguridad en español	A-13
Advertencia sobre el levantamiento del chasis	A-13
Advertencia de las tapaderas en blanco	A-13
Advertencia en caso de tormenta eléctrica	A-13
Advertencia de instalación	A-13
Advertencia de radiación láser invisible	A-13
Advertencia de la batería de litio	A-13
Advertencia sobre la tensión de operación	A-13
Advertencia sobre la desconexión de la fuente	A-13
Advertencia sobre una apropiada conexión a tierra	A-14
Leer “información importante de seguridad”	A-14
Advertencia de acceso restringido	A-14
Advertencia de pulsera antiestática	A-14
Clase de seguridad	A-14
Index	Index-1

About This Guide

This *OmniSwitch 6800 Series Hardware Users Guide* describes your switch hardware components and basic switch hardware procedures.

Supported Platforms

The information in this guide applies to the following products:

- OmniSwitch 6800-24
- OmniSwitch 6800-48
- OmniSwitch 6800-U24
- OmniSwitch 6800-24L
- OmniSwitch 6800-48L

Unsupported Platforms

The information in this guide does not apply to the following products:

- OmniSwitch (original version with no numeric model name)
- OmniSwitch 6624
- OmniSwitch 6648
- OmniSwitch 6600-U24
- OmniSwitch 6600-P24
- OmniSwitch 6602-24
- OmniSwitch 6602-48
- OmniSwitch 7700
- OmniSwitch 7800
- OmniSwitch 8800
- Omni Switch/Router
- OmniStack
- OmniAccess

Who Should Read this Manual?

The audience for this users guide is network administrators and IT support personnel who need to configure, maintain, and monitor switches and routers in a live network. However, anyone wishing to gain knowledge on the OmniSwitch 6800 Series hardware will benefit from the material in this guide.

When Should I Read this Manual?

Read this guide as soon as you are ready to familiarize yourself with your switch hardware components. You should have already stepped through the first login procedures and read the brief hardware overviews in the *OmniSwitch 6800 Series Getting Started Guide*.

You should already be familiar with the very basics of the switch hardware, such as module LEDs and module installation procedures. This manual will help you understand your switch hardware components (e.g., chassis, stacking ports and cables, backup power supplies, etc.) in greater depth.

What is in this Manual?

This users guide includes the following hardware-related information:

- Descriptions of stand-alone and stacked configurations.
- Descriptions of “availability” features.
- Descriptions of chassis types (OS6800-24 and OS6800-48).
- Instructions for mounting the chassis.
- Descriptions of hardware components (status LEDs, chassis, stacking ports and cables, backup power supplies, etc.).
- Managing a stand-alone chassis.
- Setting up stacks.
- Managing stacks.
- Hardware-related Command Line Interface (CLI) commands.

What is Not in this Manual?

The descriptive and procedural information in this manual focuses on switch hardware. It includes information on some CLI commands that pertain directly to hardware configuration, but it is not intended as a software users guide. There are several OmniSwitch 6800 Series users guides that focus on switch software configuration. Consult those guides for detailed information and examples for configuring your switch software to operate in a live network environment. See [“Documentation Roadmap” on page -xi](#) and [“Related Documentation” on page -xiii](#) for further information on software configuration guides available for your switch.

How is the Information Organized?

This users guide provides an overview of OmniSwitch 6800 Series switches in the first chapter, an overview and procedures for setting up and managing OmniSwitch 6800 Series switches in the second chapter, and an overview and procedures for managing stacks in the third chapter.

Documentation Roadmap

The OmniSwitch user documentation suite was designed to supply you with information at several critical junctures of the configuration process. The following section outlines a roadmap of the manuals that will help you at each stage of the configuration process. Under each stage, we point you to the manual or manuals that will be most helpful to you.

Stage 1: Using the Switch for the First Time

Pertinent Documentation: *OmniSwitch 6800 Series Getting Started Guide*
Release Notes

The *OmniSwitch 6800 Series Getting Started Guide* provides all the information you need to get your switch up and running the first time. This guide provides information on unpacking the switch, rack mounting the switch, installing stacking cables, installing backup power supplies, unlocking access control, setting the switch's IP address, setting up a password, and setting up stacks. It also includes succinct overview information on fundamental aspects of the switch, such as hardware LEDs, the software directory structure, stacking, CLI conventions, and web-based management.

At this time you should also familiarize yourself with the Release Notes that accompanied your switch. This document includes important information on feature limitations that are not included in other user guides.

Stage 2: Gaining Familiarity with Basic Switch Functions

Pertinent Documentation: *OmniSwitch 6800 Series Hardware Users Guide*
OmniSwitch 6800/6850/9000 Series Switch Management Guide

Once you have your switch up and running, you will want to begin investigating basic aspects of its hardware and software. Information about switch hardware is provided in the *OmniSwitch 6800 Series Hardware Users Guide*. This guide provide specifications, illustrations, and descriptions of all hardware components—e.g., chassis, stacking ports and stacking cables, backup power supplies, etc. It also includes steps for common procedures, such as removing and installing switch modules.

The *OmniSwitch 6800/6850/9000 Switch Management Guide* is the primary user guide for the basic software features on a single switch. This guide contains information on the switch directory structure, basic file and directory utilities, switch access security, SNMP, and web-based management. It is recommended that you read this guide before connecting your switch to the network.

Stage 3: Integrating the Switch Into a Network

Pertinent Documentation: *OmniSwitch 6800/6850/9000 Network Configuration Guide*
OmniSwitch 6800/6850/9000 Advanced Routing Configuration Guide

When you are ready to connect your switch to the network, you will need to learn how the OmniSwitch implements fundamental software features, such as 802.1Q, VLANs, and Spanning Tree. The *OmniSwitch 6800/6850/9000 Network Configuration Guide* contains overview information, procedures and examples on how standard networking technologies are configured in the OmniSwitch 6800 Series.

The *OmniSwitch 6800/6850/9000 Advanced Routing Configuration Guide* includes configuration information for networks using Open Shortest Path First (OSPF).

Anytime

The *OmniSwitch CLI Reference Guide* contains comprehensive information on all CLI commands supported by the switch. This guide includes syntax, default, usage, example, related CLI command, and CLI-to-MIB variable mapping information for all CLI commands supported by the switch. This guide can be consulted anytime during the configuration process to find detailed and specific information on each CLI command.

Related Documentation

The following are the titles and descriptions of all the OmniSwitch 6800 Series user manuals:

- *OmniSwitch 6800 Series Getting Started Guide*

Describes the hardware and software procedures for getting an OmniSwitch 6800 Series switch up and running. Also provides information on fundamental aspects of OmniSwitch software and stacking architecture.

- *OmniSwitch 6800 Series Hardware Users Guide*

Detailed technical specifications and procedures for the OmniSwitch 6800 Series chassis and components. This manual also includes comprehensive information on assembling and managing stacked configurations.

- *OmniSwitch CLI Reference Guide*

Complete reference to all CLI commands supported on OmniSwitch 6800, 6850, and 9000 Series switches. Includes syntax definitions, default values, examples, usage guidelines and CLI-to-MIB variable mappings.

- *OmniSwitch 6800/6850/9000 Switch Management Guide*

Includes procedures for readying an individual switch for integration into a network. Topics include the software directory architecture, image rollback protections, authenticated switch access, managing switch files, system configuration, using SNMP, and using web management software (WebView).

- *OmniSwitch 6800/6850/9000 Network Configuration Guide*

Includes network configuration procedures and descriptive information on all the major software features and protocols included in the base software package. Chapters cover Layer 2 information (Ethernet and VLAN configuration), Layer 3 information, security options (authenticated VLANs), Quality of Service (QoS), and link aggregation.

- *OmniSwitch 6800/6850/9000 Advanced Routing Configuration Guide*

Includes network configuration procedures and descriptive information on all the software features and protocols included in the advanced routing software package. Chapters cover multicast routing (DVMRP and PIM-SM), and OSPF.

- *OmniSwitch Transceivers Guide*

Includes SFP and XFP transceiver specifications and product compatibility information.

- *Technical Tips, Field Notices*

Includes information published by Alcatel-Lucent's Customer Support group.

- *Release Notes*

Includes critical Open Problem Reports, feature exceptions, and other important information on the features supported in the current release and any limitations to their support.

User Manual CD

All user guides for the OmniSwitch 6800 Series are included on the User Manual CD. This CD also includes user guides for other Alcatel-Lucent data enterprise products. In addition, it contains a stand-alone version of the on-line help system that is embedded in the OmniVista network management application.

Besides the OmniVista documentation, all documentation on the User Manual CD is in PDF format and requires the Adobe Acrobat Reader program for viewing. Acrobat Reader freeware is available at www.adobe.com.

Note. In order to take advantage of the documentation CD's global search feature, it is recommended that you select the option for *searching PDF files* before downloading Acrobat Reader freeware.

To verify that you are using Acrobat Reader with the global search option, look for the following button in the toolbar:



Note. When printing pages from the documentation PDFs, deselect Fit to Page if it is selected in your print dialog. Otherwise pages may print with slightly smaller margins.

Technical Support

An Alcatel-Lucent service agreement brings your company the assurance of 7x24 no-excuses technical support. You'll also receive regular software updates to maintain and maximize your Alcatel-Lucent product's features and functionality and on-site hardware replacement through our global network of highly qualified service delivery partners. Additionally, with 24-hour-a-day access to Alcatel-Lucent's Service and Support web page, you'll be able to view and update any case (open or closed) that you have reported to Alcatel-Lucent's technical support, open a new case or access helpful release notes, technical bulletins, and manuals. For more information on Alcatel-Lucent's Service Programs, see our web page at service.esd.alcatel-lucent.com, call us at 1-800-995-2696, or email us at support@ind.alcatel.com.

1 OmniSwitch 6800 Series

The OmniSwitch 6800 Series is an advanced fixed configuration family of Ethernet switches. These switches provide wire rate layer-2 forwarding and layer-3 routing with advanced services.

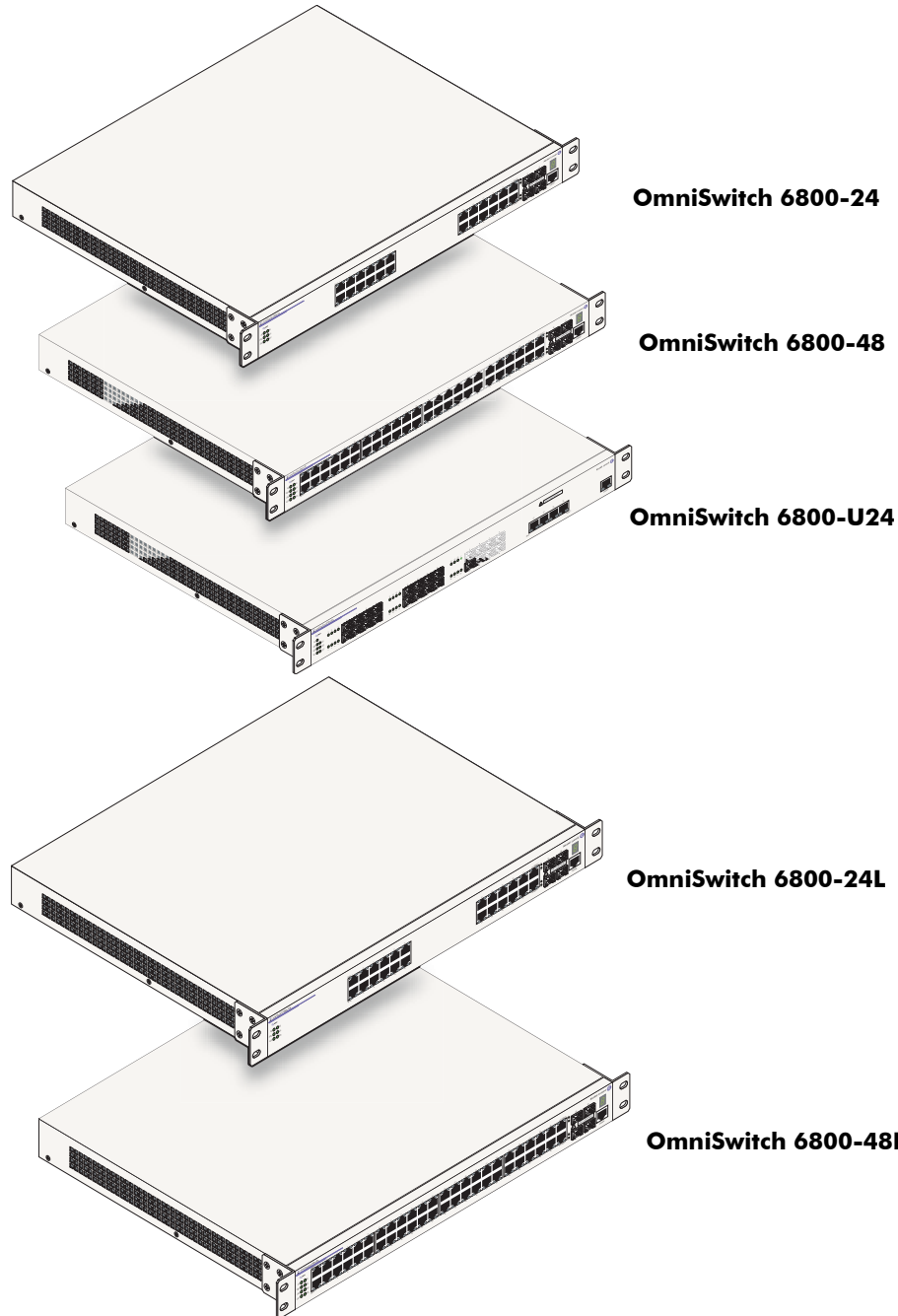

- The OmniSwitch 6800-24 (OS6800-24) is a 24 port, 10/100/1000 fixed stackable chassis.
- The OmniSwitch 6800-48 (OS6800-48) is a 48 port, 10/100/1000 fixed stackable chassis. This switch also supports a 10 Gigabit uplink module.
- The OmniSwitch 6800-U24 (OS6800-U24) is a 24 fiber 1000 Mbps SFP connector chassis. This switch also supports a 10 Gigabit uplink module.
- The OmniSwitch 6800-24L (OS6800-24L) is a 24 port fixed stackable chassis. This chassis has 20 unshared 10/100 ports, which can be upgraded to 10/100/1000 ports.
- The OmniSwitch 6800-48L (OS6800-48L) is a 48 port fixed stackable chassis. This chassis has 44 unshared 10/100 ports, which can be upgraded to 10/100/1000 ports.

Whether operating as a single switch or as a stack, the OmniSwitch 6800 Series offers effective availability, resiliency, and security features and are ideal for the following network applications:

- Enterprise workgroups/LAN wiring closets
- Edge deployments and branch offices
- L3 aggregation/distribution layer switches in three-tier networks
- Small enterprise core switching
- Quality of service (QoS) for mission critical applications
- Data center server clusters

Note on Terminology. In the user guides provided with your OmniSwitch 6800 Series switch, the terms *stack* and *virtual chassis* are interchangeable terms referring to OmniSwitch 6800 Series switches in a stacked configuration. The terms *module*, *switch*, *slot* and *element* are used to refer to individual switches within a stacked configuration. The terms *Chassis Management Module (CMM)* and *management module* refer to those switches operating in a stack either in primary or secondary management roles. OmniSwitch 6800 Series switches operating in an idle role are essentially acting as network interface modules and therefore may be referred to as *Network Interfaces (NIs)*.

Stacked Configurations

In addition to working as individual, stand-alone switches, OmniSwitch 6800 Series switches (except for the OS6800-U24) can also be linked together to form a single, high-density virtual chassis known as a *stack*.

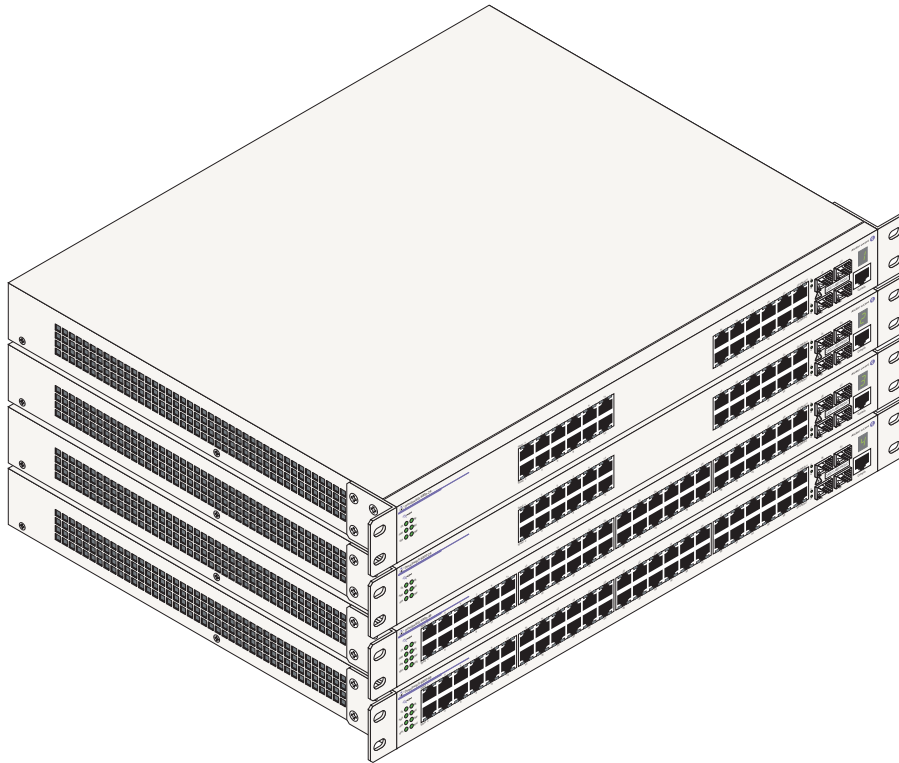

OmniSwitch 6800 Series Stacked Configuration (Stack of Four Shown)

Stacking switches provides scalability by allowing users to quickly and easily expand 10/100/1000 port density. Twenty-four 10/100/1000 ports are added for each OS6800-24 brought into the stack and forty-eight 10/100/1000 ports are added for each OS6800-48.

Up to eight switches can be stacked. OmniSwitch 6800 Series switches can be mixed and matched in *any combination* within the stack. This provides a virtual chassis with a 10/100/1000 capacity of up to 384 ports.

Note. Other stackable Alcatel-Lucent products, such as the OmniSwitch 6600 Series switch, *cannot* be added to an OmniSwitch 6800 Series virtual chassis. For comprehensive information on managing stacked configurations, refer to [Chapter 3, “Managing OmniSwitch 6800 Series Stacks.”](#)

Availability Features

The switch provides a broad variety of *availability* features. Availability features are hardware and software-based safeguards that help prevent the loss of data flow in the unlikely event of a subsystem failure. In addition, some availability features allow users to maintain or replace hardware components without powering off the switch or interrupting switch operations. Combined, these features provide added resiliency and help ensure that the switch or virtual chassis is consistently available for day-to-day network operations.

Hardware-related Availability features include:

- [Management Module Redundancy](#)
- [Software Rollback](#)
- [Backup Power Supplies](#)
- [Hot Swapping](#)
- [Hardware Monitoring](#)

Management Module Redundancy

In stacked configurations, one OmniSwitch 6800 Series switch is designated as the primary “management module” for the stack. Because the stack can be thought of as a virtual chassis, the role of this primary management switch is to monitor and manage the functions of the stack.

Similar to chassis-based switches, such as the OmniSwitch 9700 and Omniswitch 9800, the stack also allows users to assign an additional switch as a secondary management module. As with the OS9700 and OS9800, the stack’s secondary switch immediately takes over management functions in the event of a primary switch failure.

All other switches in the stack are considered *idle*, and act very much like Network Interface (NI) modules, in that they provide Ethernet ports for 10/100/1000 traffic.

The stack provides support for all idle switches during primary-to-secondary failover. In other words, if the stack’s primary switch fails or goes offline for any reason, all idle switches will continue data transmission during the secondary switch’s takeover process.

Incoming Layer 2 packets will continue to be sent to the appropriate egress port during failover. Spanning Tree will continue handling BPDUs received on the switch ports, as well as port link up and down states. The Spanning Tree topology will not be disrupted.

Note. For detailed information on primary, secondary, and idle switches, as well as the failover process, refer to [Chapter 3, “Managing OmniSwitch 6800 Series Stacks.”](#)

Software Rollback

Software rollback (also referred to as *image rollback*) essentially allows the OmniSwitch 6800 Series switches (in both standalone and stacked configurations) to return to a prior “last known good” version of software in the event of a system software problem. The switch controls software rollback through its resilient directory structure design (i.e., **/flash/working** and **/flash/certified**).

For detailed information on the software rollback feature, as well as the switch’s **/flash/working** and **/flash/certified** directories, refer to the “Managing CMM Directory Content” chapter in the *OmniSwitch 6800/6850/9000 Switch Management Guide*.

Backup Power Supplies

OmniSwitch 6800 Series switches support an optional backup power supply shelf. The backup power supply shelf is a separate, rack-mountable chassis offering power supply bays for up to eight 225 watt power supply modules. This provides redundant chassis power on a 1:1 basis.

Backup power supplies operate in active standby mode. If the primary power supply fails unexpectedly, the backup power supply automatically takes up the full power load without disrupting the switch.

Note. For more information on backup power supplies, refer to [Chapter 2, “OmniSwitch 6800 Series Chassis and Hardware Components.”](#)

Hot Swapping

Hot swapping refers to the action of adding, removing, or replacing components without powering off switches or disrupting other components in the switch or stack. This feature facilitates hardware upgrades and maintenance and allows users to easily replace components in the unlikely event of hardware failure.

The following hardware components can be hot swapped:

- OS6800-BPS-225 backup power supplies
- Backup power supply connector cables
- Backup power supply daughtercard module
- SFPs
- Modules operating in idle status within a stacked configuration (see [Chapter 3, “Managing OmniSwitch 6800 Series Stacks.”](#))
- Stacking cables (see note below)

Note. Stacking cables can be hot swapped as long as the stack is not split into two or more separate stacks in the process. In addition, a redundant cable connection must always be in place before swapping stacking cables. Otherwise, stack operations may be disrupted. For information on stacking cables, refer to [Chapter 2, “OmniSwitch 6800 Series Chassis and Hardware Components.”](#)

For instructions on hot swapping backup power supplies, refer to [Chapter 2, “OmniSwitch 6800 Series Chassis and Hardware Components.”](#) For instructions on hot swapping combo port SFPs, refer to the instruction card provided with the SFP product. For instructions on hot swapping modules within a stacked configuration, refer to [Chapter 3, “Managing OmniSwitch 6800 Series Stacks.”](#)

Hardware Monitoring

Automatic Monitoring

Automatic monitoring refers to the switch's built-in sensors that automatically monitor operations. If an error is detected (e.g., over-threshold temperature), the switch immediately sends a trap to the user. The trap is displayed on the console in the form of a text error message. (In the case of an over-threshold temperature condition, the chassis displays an amber TMP LED in addition to sending a trap.)

LEDs

LEDs, which provide visual status information, are provided on the chassis front panel. LEDs are used to indicate conditions such as hardware and software status, temperature errors, link integrity, data flow, etc. For detailed LED descriptions, refer to [Chapter 2, "OmniSwitch 6800 Series Chassis and Hardware Components."](#)

User-Driven Monitoring

User-driven hardware monitoring refers to CLI commands that are entered by the user in order to access the current status of hardware components. The user enters "show" commands that output information to the console. Monitoring information for chassis components such as the optional back up power supply, chassis temperature sensor, and chassis fans is provided in [Chapter 2, "OmniSwitch 6800 Series Chassis and Hardware Components."](#) Show commands for all features are described in detail in the *OmniSwitch CLI Reference Guide*.

Port and Fabric Capacities

OmniSwitch 6800 Series switches offer 20 non combo 10/100/1000 Ethernet ports, 44 non combo 10/100/1000 Ethernet ports, 20 non combo 1000 Mbps SFP connectors, 20 non combo 10/100 Ethernet ports, or 44 non combo 10/100 Ethernet ports. The switches also offer combo ports, which consist of four paired Gigabit Ethernet SFP connectors and four 10/100/100 Ethernet ports.

OmniSwitch 6800 Series Switching Fabric Capacity

OmniSwitch 6800-24	160 Gbps aggregate
OmniSwitch 6800-48	160 Gbps aggregate
OmniSwitch 6800-U24	80 Gbps
OmniSwitch 6800-24L	160 Gbps aggregate
OmniSwitch 6800-48L	160 Gbps aggregate

OmniSwitch 6800 Series Performance Specifications

Stacking capacity	40 Gbps
Jumbo frames	Up to 9 KB
MAC addresses	16 K

For detailed information on OmniSwitch 6800 Series features, functions, and technical specifications, refer to [Chapter 2, “OmniSwitch 6800 Series Chassis and Hardware Components”](#) and [Chapter 3, “Managing OmniSwitch 6800 Series Stacks.”](#)

OmniSwitch 6800 Series Application Examples

The following OmniSwitch 6800 Series applications are described below:

- Gigabit-to-the-desktop migration
- Server aggregation
- Layer 3 Aggregation/Distribution
- Small Enterprise core

Gigabit-to-the-Desktop Migration

OmniSwitch 6800 Series switches provide a migration path to Gigabit on the edge of the LAN. For example:

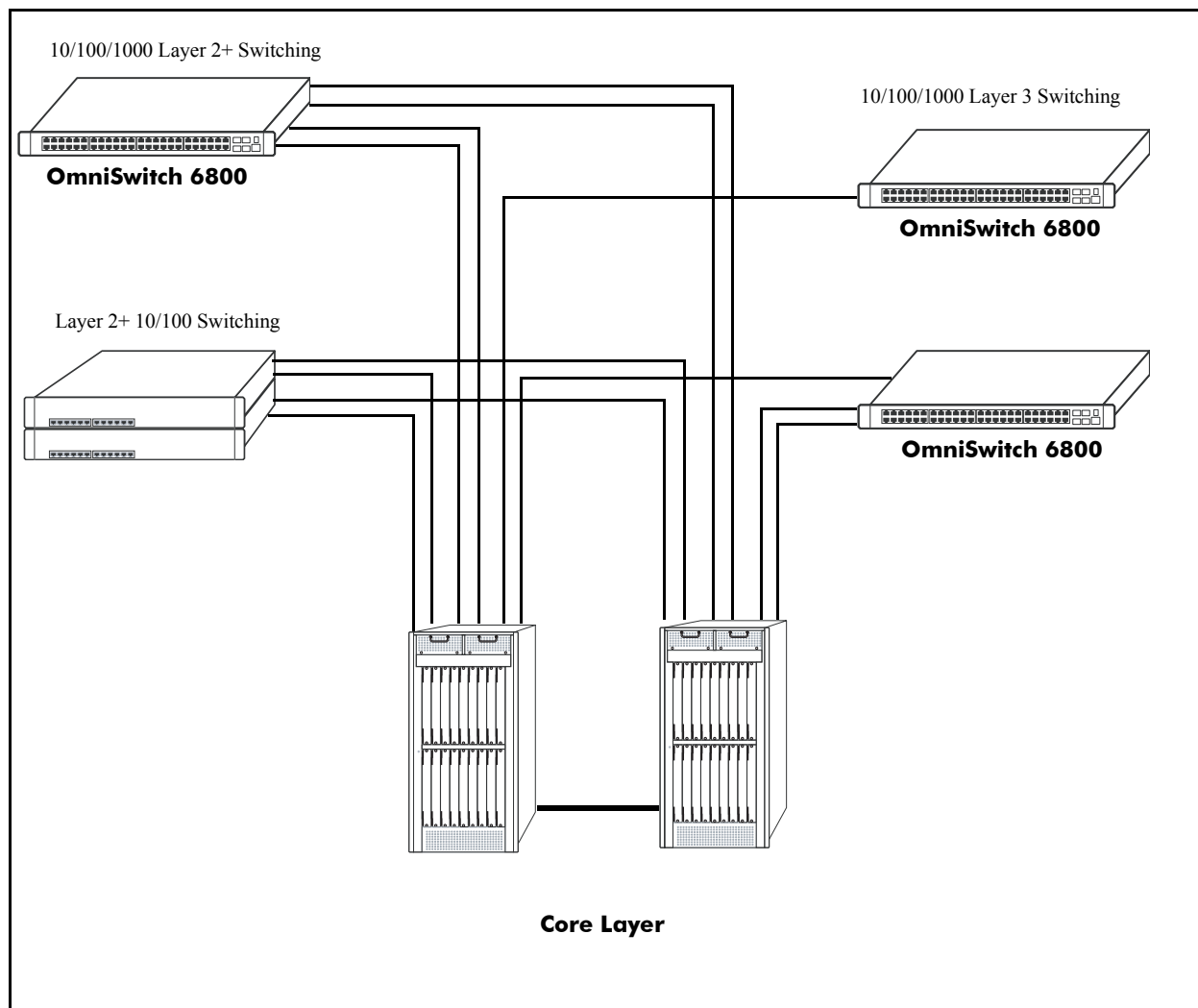

Application Example: Gigabit-to-the-Desktop Migration

Server Aggregation

The OmniSwitch 6800 Series switch is a well-suited server aggregation switch, especially for space-constrained data centers, where the switch can be installed in the same rack as the servers. For example:

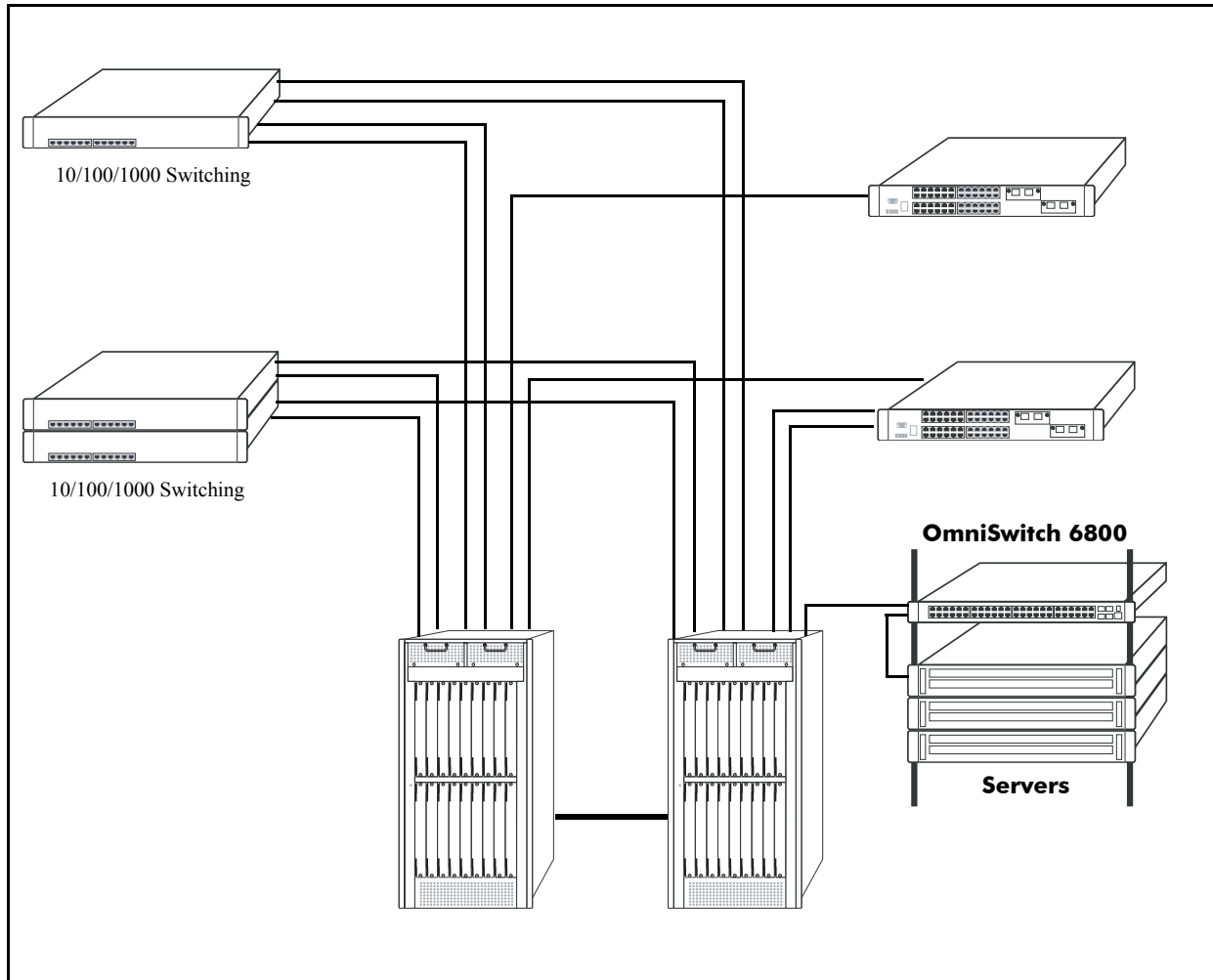

Application Example: Server Aggregation

Layer 3 Aggregation/Distribution

OmniSwitch 6800 Series switches placed in the distribution layer of three-tier networks provide high-capacity, wire speed Layer 2 switching, Layer 3 routing, and intelligent services near the edge of the network. For example:

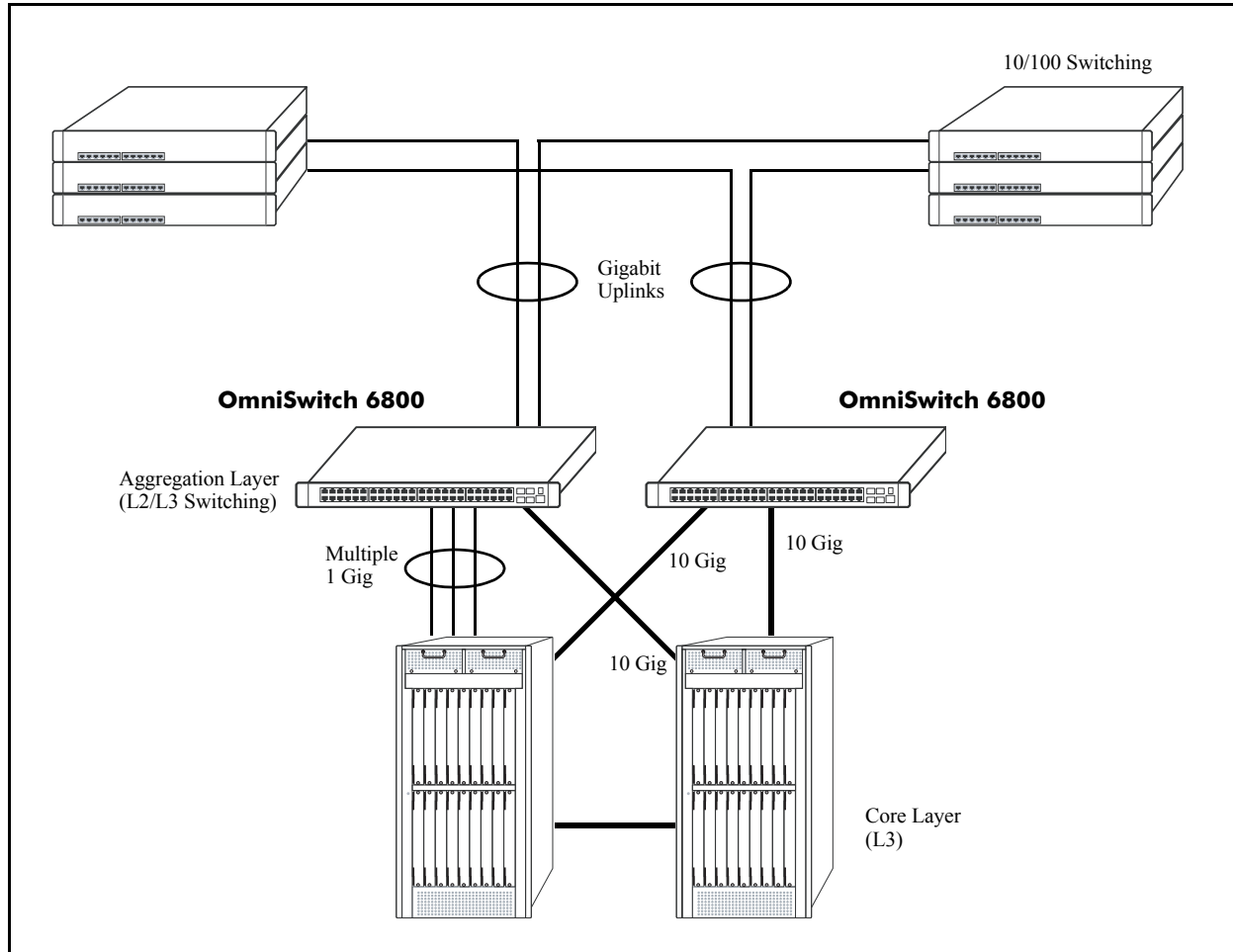

Application Example: Layer 3 Aggregation/Distribution

Small Enterprise Core

With its high-speed switching capacity, supported Layer 3 routing protocols, advanced network services, and wire speed 10 Gigabit capability, the OmniSwitch 6800 Series provides effective core switching for smaller Enterprise networks (200-500 ports). For example:

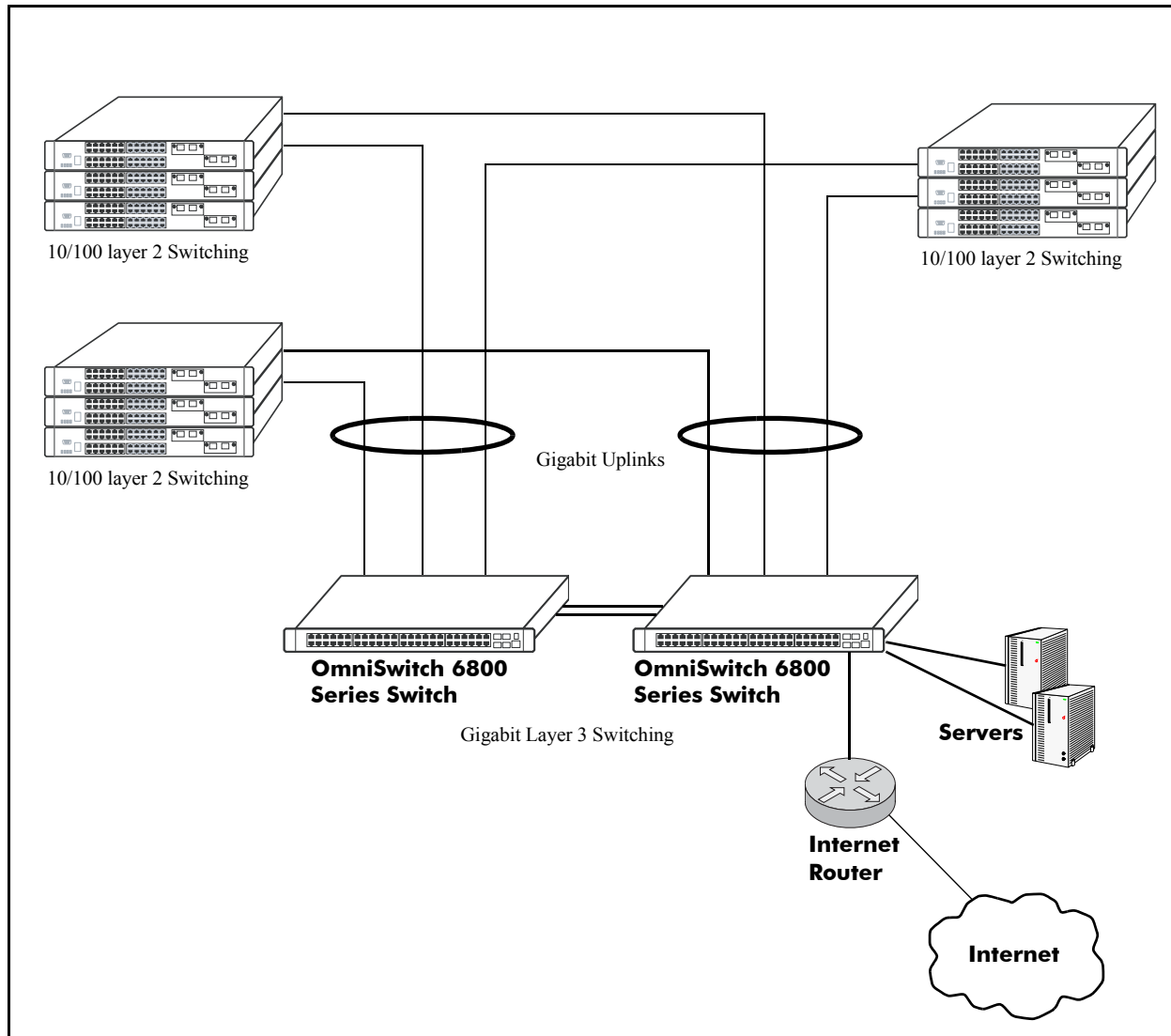

Application Example: Small Enterprise Core

2 OmniSwitch 6800 Series Chassis and Hardware Components

OmniSwitch 6800 Series switches are available in five stackable chassis configurations—the 24-port OmniSwitch 6800-24 (OS6800-24), OmniSwitch 6800-U24 (OS6800-U24), OmniSwitch 6800-24L (OS6800-24L), the 48-port OmniSwitch 6800-48 (OS6800-48), and OmniSwitch 6800-48L (OS6800-48L). This chapter includes detailed information on these chassis types. Topics include:

- OmniSwitch 6800 Series chassis descriptions
- Technical specifications
- Mounting the switch
- Setting up a stacked configuration
- Booting OmniSwitch 6800 Series switches
- Monitoring the chassis
- Backup power supply components
- Monitoring backup power supply status
- Pinouts, power cord, and console port specifications

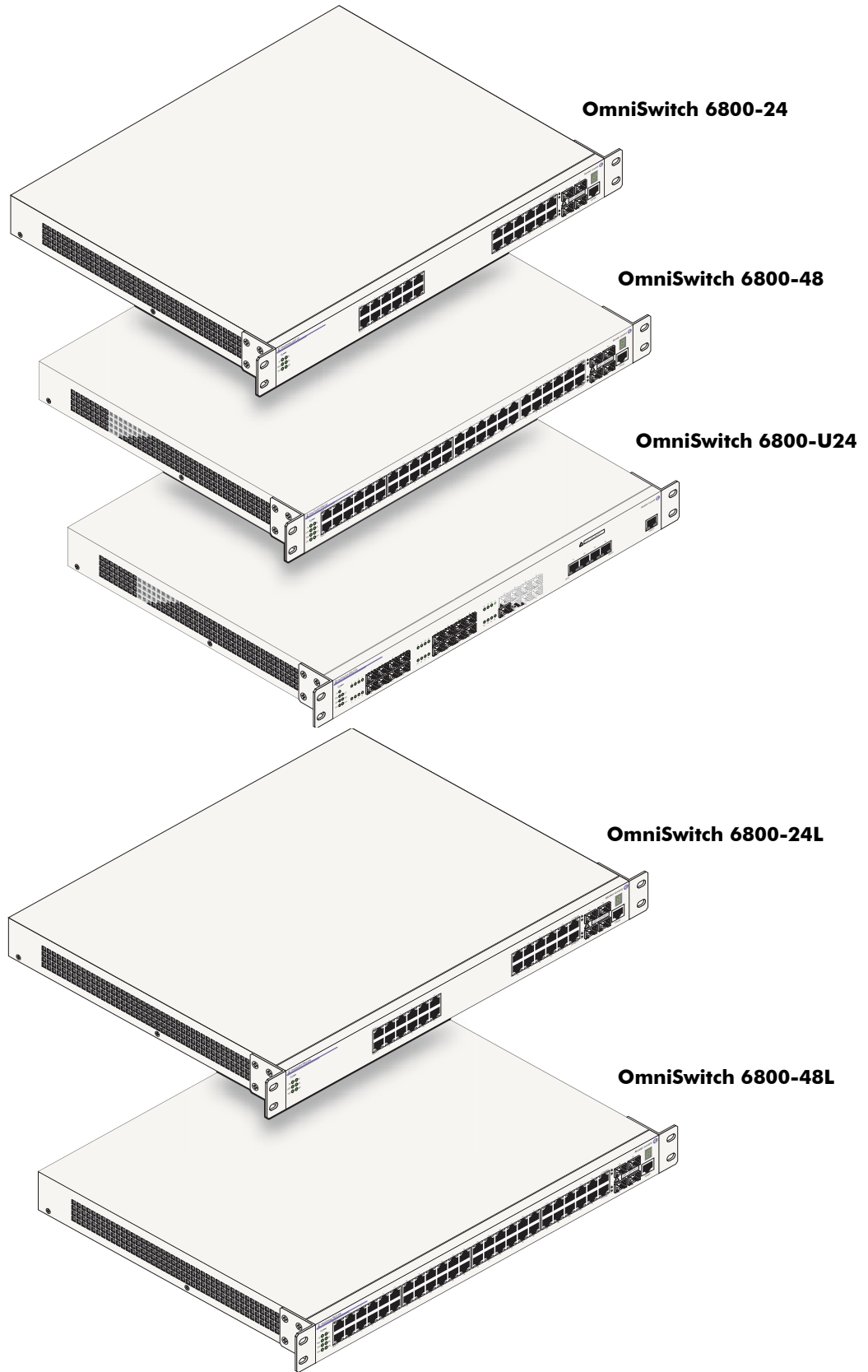

OmniSwitch 6800-24

The OmniSwitch 6800-24 is a stackable edge/workgroup switch offering 24 10/100/1000Base-T ports, as well as four combo SFP connectors for high speed connections.

The front panel of the OS6800-24 chassis contains the following major components:

- System status and slot indicator LEDs
- (24) 10/100/1000Base-T ports
- (4) Combo SFP connectors for 1000Base-X connections
- Console port (RJ-45)

Refer to the illustration below for more front panel information. For detailed LED descriptions, refer to [page 2-13](#). For information on the chassis rear panel, refer to [page 2-15](#).

System Status LEDs

For detailed information on OS6800-24 system status and other LEDs, refer to [page 2-13](#).

Combo SFP Connectors

The OS6800-24 provides four combo SFP connectors for 1000Base-X high-speed connections.

By default, when an SFP is installed in a combo port, it takes over the port number of the corresponding RJ-45 Ethernet port. In other words, if an SFP is installed in the slot labeled 24, Ethernet port 24 is no longer available and cannot be used for 10/100/1000 traffic. This default setting is referred to as “preferred fiber.” Refer to “Configuring Ethernet Ports” in the *Network Configuration Guide* for detailed information, including steps for configuring combo port settings.

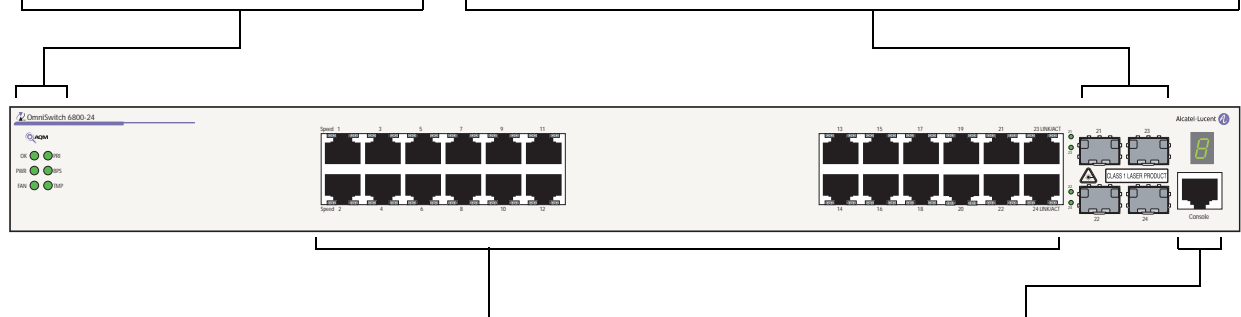

10/100/1000Mbps Ports

The OS6800-24 provides 20 fixed 10/100/1000BaseT non combo ports (1–20) and 4 fixed 10/100/1000BaseT combo ports (21–24). These ports are auto-sensing and auto-MDIX and use RJ-45 connectors.

Console Port

The OS6800-24 front panel provides one RJ-45 port for console connections. Console connections are used by network administrators for switch management. This female RJ-45 connector provides a DTE console connection.

OmniSwitch 6800-24 Front Panel

OS6800-24 Specifications

Total 10/100/1000Base-T ports per switch	24
Total combo SFP connectors per switch	4
Total 10/100/1000Base-T ports per stack	192 (stack of eight switches)
Total combo SFP connectors per stack	32 (stack of eight switches)
Fabric capacity	160 Gbps
Power	150W AC/DC power supply, providing +12V @ 12.5A; 90-264VAC50-60 Hz universal input
Total available power supplies	2 (one factory-installed power supply and one optional backup power supply)
Flash memory size	64 MB
RAM memory size	256 MB SDRAM
Overall Width (rack-mount flanges included)	19 inches, approx.
Chassis Width (rack-mount flanges not included)	17.32 inches
Height	1.73 inches
Height (rack units)	1 RU
Chassis Depth	16.73 inches
Weight	13.88 lbs. (6.30 Kg)
Humidity	5% to 90% Relative Humidity (Operating) 0% to 95% Relative Humidity (Storage)
Operating Temperature	0 to 45 degrees, Celsius
Storage Temperature	-20 to 70 degrees, Celsius
Altitude	Operating altitude: sea level at 40 degrees, Celsius and 10000 feet at 0 degrees, Celsius Storage altitude: sea level at 40000 feet

OmniSwitch 6800-48

The OmniSwitch 6800-48 is a stackable edge/workgroup switch offering 48 10/100/1000Base-T ports, as well as four combo SFP connectors for high speed connections.

The front panel of the OS6800-48 chassis contains the following major components:

- System status and slot indicator LEDs
- (48) 10/100/1000Base-T ports
- (4) Combo SFP connectors for 1000Base-X connections
- Console port (RJ-45)

An Optional 10 Gigabit module is also supported (see [page 2-34](#)).

Refer to the illustration below for more front panel information. For detailed LED descriptions, refer to [page 2-13](#). For information on the chassis rear panel, refer to [page 2-15](#).

Combo SFP Connectors

The OS6800-48 provides four combo SFP connectors for 1000Base-X high-speed connections.

By default, when an SFP is installed in a combo port, it takes over the port number of the corresponding RJ-45 Ethernet port. In other words, if an SFP is installed in the slot labeled 45, Ethernet port 45 is no longer available and cannot be used for 10/100/1000 traffic. This default setting is referred to as “preferred fiber.” Refer to “Configuring Ethernet Ports” in the *Network Configuration Guide* for detailed information, including steps for configuring combo port settings.

Status and Slot Indicator LEDs

For detailed information on OS6800-48 status and slot indicator LEDs, refer to [page 2-13](#).

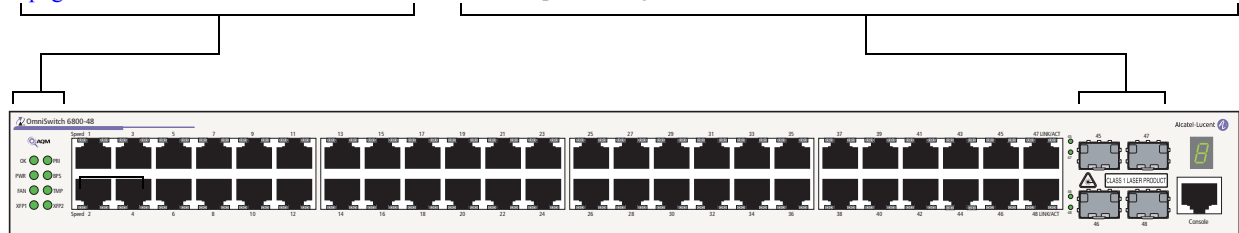

10/100/1000Mbps Ports

The OS6800-48 provides 44 fixed 10/100/1000BaseT ports (1–44) and 4 fixed 10/100/1000BaseT combo ports (45–48). These ports are auto-sensing and auto-MDIX and use RJ-45 connectors.

Console Port

The OS6800-48 front panel provides one RJ-45 port for console connections. Console connections are used by network administrators for switch management. This female RJ-45 connector provides a DTE console connection.

OmniSwitch 6800-48 Front Panel

OS6800-48 Specifications

Total 10/100/1000Base-T ports per switch	48
Total combo SFP connectors per switch	4
Total 10/100/1000Base-T ports per stack	384 (stack of eight switches)
Total combo SFP connectors per stack	32 (stack of eight switches)
Fabric capacity	160 Gbps
Power	150W AC/DC power supply, providing +12V @ 12.5A; 90-264VAC50-60 Hz universal input
Total available power supplies	2 (one factory-installed power supply and one optional backup power supply)
Flash memory size	64 MB
RAM memory size	256 MB SDRAM
Overall Width (rack-mount flanges included)	19 inches, approx.
Chassis Width (rack-mount flanges not included)	17.32 inches
Height	1.73 inches
Height (rack units)	1 RU
Chassis Depth	16.73 inches
Weight	14.41 lbs. (6.54 Kg)
Humidity	5% to 90% Relative Humidity (Operating) 0% to 95% Relative Humidity (Storage)
Operating Temperature	0 to 45 degrees, Celsius
Storage Temperature	-20 to 70 degrees, Celsius
Altitude	Operating altitude: sea level at 40 degrees, Celsius and 10000 feet at 0 degrees, Celsius Storage altitude: sea level at 40000 feet

OmniSwitch 6800-U24

The OmniSwitch 6800-U24 is an edge/workgroup switch offering 24 1000Base-X SFP connectors, as well as four combo 10/100/1000Base-T ports.

The front panel of the OS6800-U24 chassis contains the following major components:

- System status and slot indicator LEDs
- (24) 1000Base-X SFP connectors
- (4) Combo RJ-45 10/100/1000Base-T ports
- Console port (RJ-45)

An Optional 10 Gigabit module is also supported (see [page 2-15](#)).

Note. The OmniSwitch 6800-U24 operates in stand-alone mode only. It does not support stacking.

Refer to the illustration below for more front panel information. For detailed LED descriptions, refer to [page 2-13](#). For information on the chassis rear panel, refer to [page 2-15](#).

Combo RJ-45 10/100/1000 Ports

The OS6800-U24 provides four combo 10/100/1000BaseT ports. These ports are auto-sensing and auto-MDIX and use RJ-45 connectors.

By default, when an SFP is installed in a combo port, it takes over the port number of the corresponding RJ-45 Ethernet port. In other words, if an SFP is installed in the slot labeled 24, Ethernet port 24 is no longer available and cannot be used for 10/100/1000 Mbps traffic. This default setting is referred to as “preferred fiber.” Refer to “Configuring Ethernet Ports” in the *Network Configuration Guide* for detailed information, including steps for configuring combo port settings.

System Status LEDs

For detailed information on OS6800-U24 system status and other LEDs, refer to [page 2-13](#).

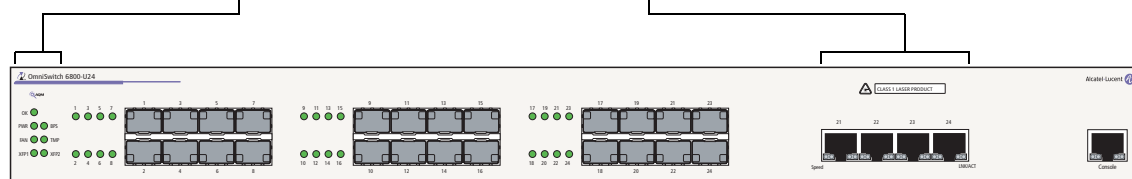

1000 Mbps SFP Connectors

The OS6800-U24 provides 20 non combo SFP connectors for 1000Base-X SFP transceivers (1–20) and 4 combo SFP connectors for 1000Base-X SFP transceivers (21–24).

Console Port

The OS6800-U24 front panel provides one RJ-45 port for console connections. Console connections are used by network administrators for switch management. This female RJ-45 connector provides a DTE console connection.

OmniSwitch 6800-U24 Front Panel

OS6800-U24 Specifications

Total 1000Base-X SFP connectors per switch	24
Total combo 10/100/1000Base-T ports per switch	4
Fabric capacity	80 Gbps
Power	150W AC/DC power supply, providing +12V @ 12.5A; 90-264VAC50-60 Hz universal input
Total available power supplies	2 (one factory-installed power supply and one optional backup power supply)
Flash memory size	64 MB
RAM memory size	256 MB SDRAM
Overall Width (rack-mount flanges included)	19 inches, approx.
Chassis Width (rack-mount flanges not included)	17.32 inches
Height	1.73 inches
Height (rack units)	1 RU
Chassis Depth	16.73 inches
Weight	13.4 lbs. (5.0 Kg)
Humidity	5% to 90% Relative Humidity (Operating) 0% to 95% Relative Humidity (Storage)
Operating Temperature	0 to 45 degrees, Celsius
Storage Temperature	-20 to 70 degrees, Celsius
Altitude	Operating altitude: sea level at 40 degrees, Celsius and 10000 feet at 0 degrees, Celsius Storage altitude: sea level at 40000 feet

OmniSwitch 6800-24L

The OmniSwitch 6800-24L is a stackable edge/workgroup switch offering 24 10/100Base-T ports, as well as four combo SFP connectors for high speed connections.

The front panel of the OS6800-24L chassis contains the following major components:

- System status and slot indicator LEDs
- (20) 10/100Base-T ports
- (4) Combo 10/100/1000Base-T ports
- (4) Combo SFP connectors for 1000Base-X connections
- Console port (RJ-45)

Note. The 20 (non combo ports) 10/100Base-T ports on the OmniSwitch 6800-24L can be upgraded to 10/100/1000Base-T ports. Please contact your Alcatel-Lucent representative for more information.

Refer to the illustration below for more front panel information. For detailed LED descriptions, refer to [page 2-13](#). For information on the chassis rear panel, refer to [page 2-15](#).

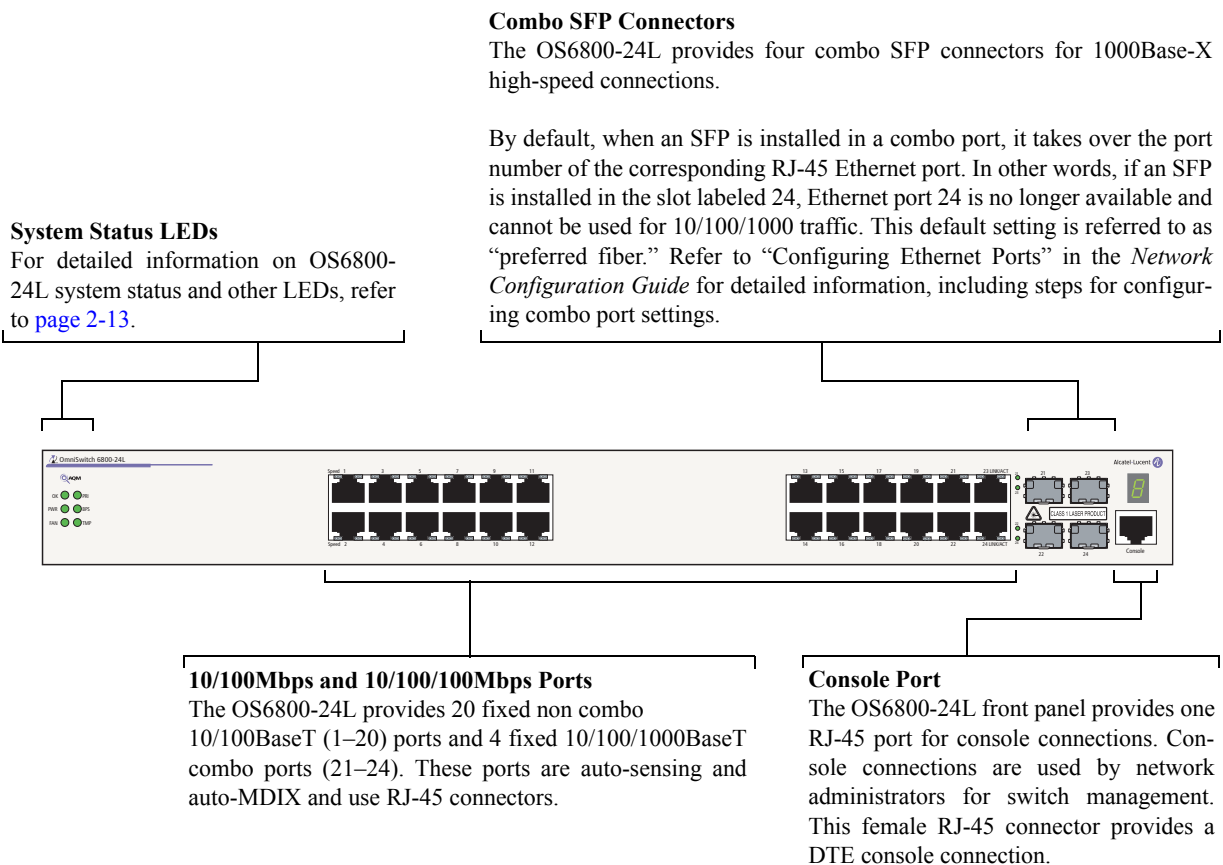

OmniSwitch 6800-24L Front Panel

OS6800-24L Specifications

Total 10/100/Base-T ports per switch	20
Total 10/100/1000Base-T combo ports per switch	4
Total combo SFP connectors per switch	4
Total 10/100Base-T ports per stack	160 (stack of eight switches)
Total combo SFP connectors per stack	32 (stack of eight switches)
Fabric capacity	160 Gbps
Power	150W AC/DC power supply, providing +12V @ 12.5A; 90-264VAC50-60 Hz universal input
Total available power supplies	2 (one factory-installed power supply and one optional backup power supply)
Flash memory size	64 MB
RAM memory size	256 MB SDRAM
Overall Width (rack-mount flanges included)	19 inches, approx.
Chassis Width (rack-mount flanges not included)	17.32 inches
Height	1.73 inches
Height (rack units)	1 RU
Chassis Depth	16.73 inches
Weight	13.88 lbs. (6.30 Kg)
Humidity	5% to 90% Relative Humidity (Operating) 0% to 95% Relative Humidity (Storage)
Operating Temperature	0 to 45 degrees, Celsius
Storage Temperature	-20 to 70 degrees, Celsius
Altitude	Operating altitude: sea level at 40 degrees, Celsius and 10000 feet at 0 degrees, Celsius Storage altitude: sea level at 40000 feet

OmniSwitch 6800-48L

The OmniSwitch 6800-48L is a stackable edge/workgroup switch offering 48 10/100/Base-T ports, as well as four combo SFP connectors for high speed connections.

The front panel of the OS6800-48L chassis contains the following major components:

- System status and slot indicator LEDs
- (44) 10/100Base-T ports
- (4) Combo 10/100/1000Base-T ports
- (4) Combo SFP connectors for 1000Base-X connections
- Console port (RJ-45)

An Optional 10 Gigabit module is also supported (see [page 2-15](#)).

Note. The 44 (non combo ports) 10/100Base-T ports on the OmniSwitch 6800-48L can be upgraded to 10/100/1000Base-T ports. Please contact your Alcatel-Lucent representative for more information.

Refer to the illustration below for more front panel information. For detailed LED descriptions, refer to [page 2-13](#). For information on the chassis rear panel, refer to [page 2-15](#).

Status and Slot Indicator LEDs

For detailed information on OS6800-48L status and slot indicator LEDs, refer to [page 2-13](#).

Combo SFP Connectors

The OS6800-48L provides four combo SFP connectors for 1000Base-X high-speed connections.

By default, when an SFP is installed in a combo port, it takes over the port number of the corresponding RJ-45 Ethernet port. In other words, if an SFP is installed in the slot labeled 45, Ethernet port 45 is no longer available and cannot be used for 10/100/1000 traffic. This default setting is referred to as “preferred fiber.” Refer to “Configuring Ethernet Ports” in the *Network Configuration Guide* for detailed information, including steps for configuring combo port settings.

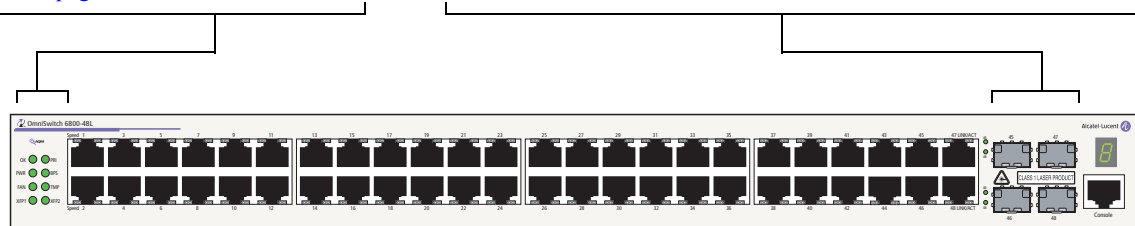

10/100Mbps and 10/100/1000 Ports

The OS6800-48L provides 44 fixed 10/100BaseT non combo ports (1–44) and 4 fixed 10/100/1000BaseT combo ports (45–48). These ports are auto-sensing and auto-MDIX and use RJ-45 connectors.

Console Port

The OS6800-48L front panel provides one RJ-45 port for console connections. Console connections are used by network administrators for switch management. This female RJ-45 connector provides a DTE console connection.

OmniSwitch 6800-48L Front Panel

OS6800-48L Specifications

Total 10/100Base-T ports per switch	44
Total 10/100/1000Base-T combo ports per switch	4
Total combo SFP connectors per switch	4
Total 10/100Base-T ports per stack	352 (stack of eight switches)
Total combo SFP connectors per stack	32 (stack of eight switches)
Fabric capacity	160 Gbps
Power	150W AC/DC power supply, providing +12V @ 12.5A; 90-264VAC50-60 Hz universal input
Total available power supplies	2 (one factory-installed power supply and one optional backup power supply)
Flash memory size	64 MB
RAM memory size	256 MB SDRAM
Overall Width (rack-mount flanges included)	19 inches, approx.
Chassis Width (rack-mount flanges not included)	17.32 inches
Height	1.73 inches
Height (rack units)	1 RU
Chassis Depth	16.73 inches
Weight	14.41 lbs. (6.54 Kg)
Humidity	5% to 90% Relative Humidity (Operating) 0% to 95% Relative Humidity (Storage)
Operating Temperature	0 to 45 degrees, Celsius
Storage Temperature	-20 to 70 degrees, Celsius
Altitude	Operating altitude: sea level at 40 degrees, Celsius and 10000 feet at 0 degrees, Celsius Storage altitude: sea level at 40000 feet

Status LEDs

LEDs provide visual status information. These “status lights” are used to indicate conditions such as hardware and software status, primary role status (stacked configurations), power supply status, fan and temperature errors, 10 Gigabit uplink status (when applicable), slot number information, data speed, link integrity, and activity. Refer to the diagram below for detailed information on LED states.

Ethernet Port LEDs

10/100 and 10/100/1000 Ethernet ports have two built-in status LEDs. These LEDs indicate the data speed and link/activity status for each corresponding Ethernet port. 1000 Mbps SFP connectors have a single LED for activity. See [page 2-14](#) for more information.

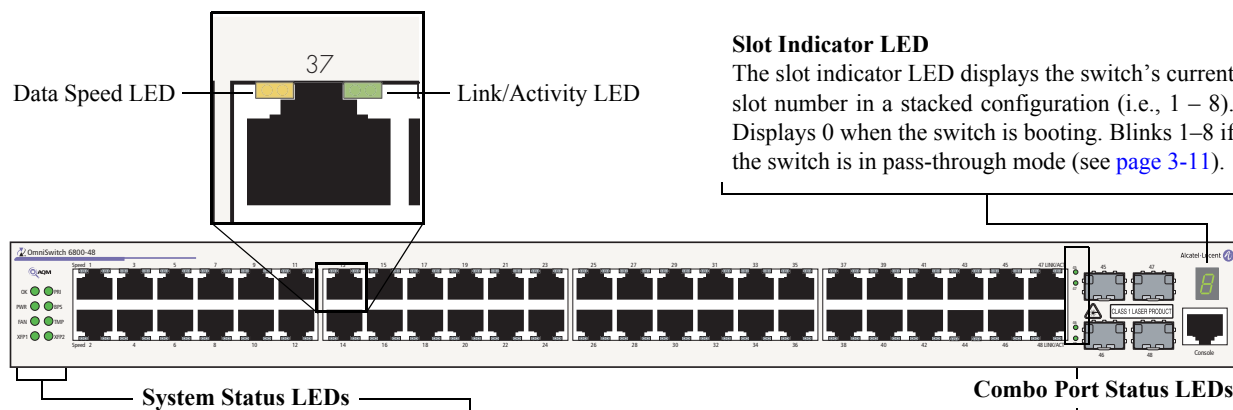

Slot Indicator LED

The slot indicator LED displays the switch’s current slot number in a stacked configuration (i.e., 1 – 8). Displays 0 when the switch is booting. Blinks 1–8 if the switch is in pass-through mode (see [page 3-11](#)).

System Status LEDs

OK. Solid green when the switch has passed hardware diagnostic tests and the system software is operational. Solid amber when a hardware or system software failure occurs. Blinks amber when the software is in a transitional state (e.g., when software is being downloaded to the switch).

PRI. Solid green when the switch is either a stand-alone switch or the primary switch in a stack; solid amber if the switch status is secondary; off if the switch is idle (i.e., neither primary nor secondary).

PWR. Solid green when the primary (i.e., factory-installed) power supply status is OK and the power supply is operating normally. Solid amber in the event of a power supply failure.

BPS. Solid green when an optional redundant power supply is installed and operational. Solid amber if no redundant power supply is installed, or if a redundant power supply failure occurs.

FAN. Solid green when all fans are running at normal speed. Solid amber if a fan error occurs (i.e., one or more fans are not running at normal speed).

TMP. Solid green when the switch is operating within the allowed temperature range; displays solid amber if a temperature error occurs (i.e., the switch is operating outside the temperature range).

XFPI. Displays the status of the 10 Gigabit port installed in the first XFP connector (located on the switch’s rear panel). Solid green when the port is up. Blinks green when the port is transmitting or receiving packets in a link up state. Off when no link is detected.

XFPI2. Displays the status of the 10 Gigabit port installed in the second XFP connector (located on the switch’s rear panel). Solid green when the port is up. Blinks green when the port is transmitting or receiving packets in a link up state. Off when no link is detected.

Combo Port Status LEDs

Displays solid green when an SFP is installed in the corresponding port and a link state exists; blinks green when transmitting or receiving traffic; off when no activity is present or no SFP is installed.

By default, when an SFP is installed, it takes over the port number of the corresponding RJ-45 Ethernet port. If an SFP is installed in the slot labeled 45, Ethernet port 45 is no longer available and cannot be used for 10/100/1000 traffic. For detailed information on changing combo port settings, see “Configuring Ethernet Ports” in the *Network Configuration Guide*.

Front Panel LED Descriptions (OS6800-48 Shown)

10/100/1000 LEDs

There are two LEDs on 10/100/1000 ports. The left-hand LED is the data speed LED. Displays solid green for 1000 Mbps; displays amber for 100 Mbps; off for 10 Mbps or no traffic flow. The right-hand LED is the link/activity status LED. Displays solid green when a link state exists; blinks green to show activity (transmitting or receiving traffic); off when no activity is present.

1000 SFP LEDs

There is a single LED for 1000 Mbps SFP connectors. Displays solid green for a valid link; blinks green when transmitting or receiving packets in a link up state; off when no link is detected.

10/100 LEDs

There are two LEDs on 10/100 ports. The left-hand LED is the data speed LED. Displays solid green for 100 Mbps; displays amber for 10 Mbps; off for no traffic flow. The right-hand LED is the link/activity status LED. Displays solid green when a link state exists; blinks green to show activity (transmitting or receiving traffic); off when no activity is present.

Rear Panel

The rear panel of OmniSwitch 6800 Series switches contains the following major components:

- Factory-installed power supply and power connector socket (all OmniSwitch 6800 Series switches)
- Backup power supply bay for optional OS6800-BPS-225 power supply (all OmniSwitch 6800 Series switches)
- Stacking ports (all OmniSwitch 6800 Series switches except for the OmniSwitch 6800-U24)
- 10 Gigabit XFP module connector (all OmniSwitch 6800 Series switches except for the OmniSwitch 6800-24 and OmniSwitch 6800-24L)

Power Connector Socket

Type IEC-320-C13. Supports one 10 amp power cord. OmniSwitch 6800 Series switches do not provide on/off switches; the power cord is the switch's only disconnect device.

It is recommended that you use only Alcatel-Lucent provided power cords.

Stacking Ports A and B

Connector ports for use in stacking OmniSwitch 6800 Series switches into a virtual chassis. For detailed information on stacking switches, refer to [page 2-22](#), as well as “[Managing OmniSwitch 6800 Series Stacks](#)” on [page 3-1](#).

Note: The OS6800-U24 does not support stacking. On these switches, this section of the rear panel is blank.

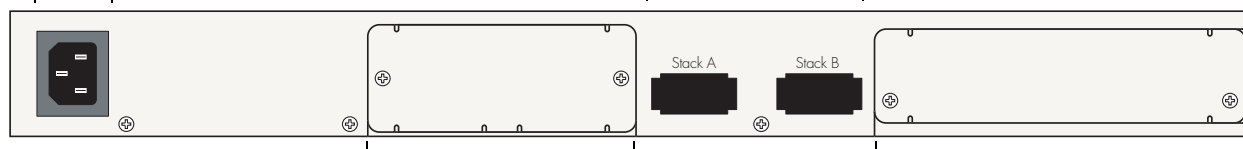

Backup Power Supply Bay

Slot for optional user-installable OS6800-BPS-225 backup power supply connector. For more information on the backup power supply, refer to the sections, “[OS6800-BPS-SHLF Backup Power Supply Shelf](#)” on [page 2-40](#) and “[OS6800-BPS-225 225W Backup Power Supply](#)” on [page 2-42](#).

10 Gigabit XFP Module Slot

Reserved for use with two-port 10 Gigabit XFP module. Refer to “[OS6800-XNI-U2 10 Gigabit Expansion Module](#)” on [page 2-34](#) for more information.

Note: The 10 Gigabit XFP Module is not supported on OS6800-24 and OS6800-24L switches. On these switches, this section of the rear panel is blank.

OmniSwitch 6800 Series Rear Panel

Mounting the Switch

Note. If you are relocating the switch, be sure to power it down and remove all network, stacking, and power cables before moving.

Airflow Considerations

Be sure that your switch is placed in a well-ventilated, static-free environment. Always allow adequate clearance at the front, rear, and sides of the switch.

The following diagram shows recommended minimum clearances for adequate chassis airflow and access to components at the rear of the chassis—e.g., backup power supply connectors and power cord(s).

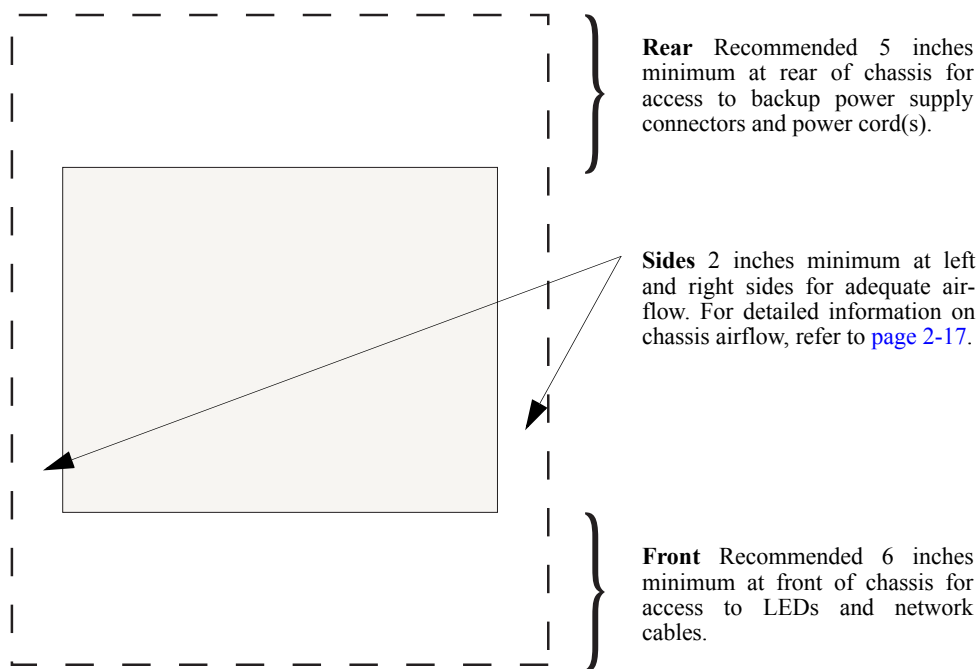

OmniSwitch 6800 Series Chassis Top View

Note. Never obstruct the air vents located at the sides of the chassis. Obstructing these vents can cause switch failure. Clearance is not required at the top and bottom of the chassis. For detailed chassis airflow diagrams, refer to “[Chassis Airflow](#)” on [page 2-17](#).

Chassis Airflow

The fans pull air from the air intake vent located at the left-hand side of the chassis. The air is directed horizontally through the chassis and past the circuit board. Airflow is then exhausted through the fan vents at the right-hand side of the chassis. Refer to the illustrations below for more information.

1. Air Intake. The six chassis fans pull air from the main air intake vent located at the left-hand side of the chassis.

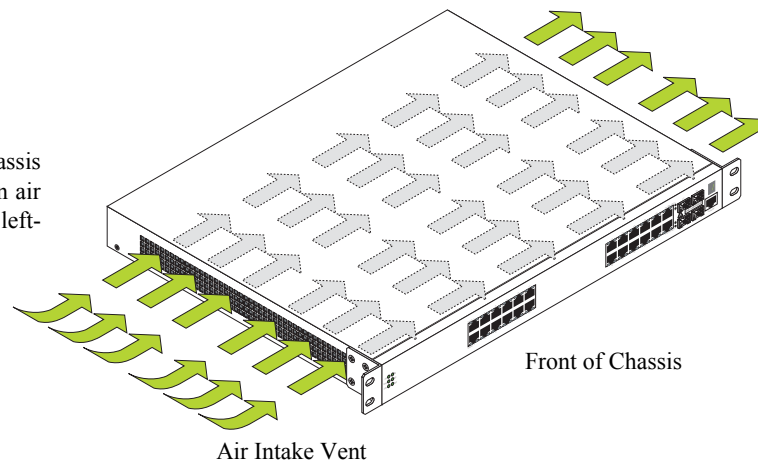

Left Side Air Intake Vent

2. Airflow. The air from the intake vent is directed through the chassis past the circuit board. This airflow provides required cooling for chassis components.

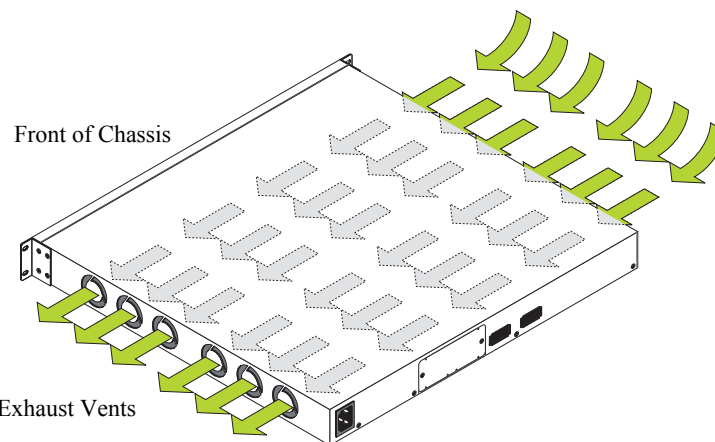

3. Air Exhaust. The airflow is exhausted through the six fan exhaust vents at the right-hand side of the chassis.

Right Side Fan Exhaust Vents

Important. Maintain a clearance of at least two inches at the left and right sides. Otherwise, airflow may become restricted. Restricted airflow can cause your switch to overheat; overheating can lead to switch failure. See [“Airflow Considerations”](#) on page 2-16 for more information on chassis clearances.

Blank Cover Panels

Blank cover panels are provided with your switch and are used to cover empty backup power supply bays and 10 Gigabit uplink bays (all OmniSwitch 6800 Series switches except for the OmniSwitch 6800-24 and OmniSwitch 6800-24L). These cover panels play an important role in chassis airflow and temperature management. They also protect the switch's processor board and other sensitive internal switch components from physical damage by closing off the chassis.

When blank cover panels are missing, air does not take the direct route from the air intake vent, through the chassis, and then out through the fan exhaust vents (see [page 2-17](#)). Instead, a portion of the airflow is allowed to be drawn in through the rear of the chassis. As a result, normal airflow is disrupted and an extra task is placed on the fans to cool the chassis.

If your switch is not equipped with a backup power supply connection or 10 Gigabit uplink, and blank cover panels are *not installed* over empty bay locations, airflow is adversely affected. Because they regulate airflow and help protect internal chassis components, blank cover panels should remain installed over empty rear panel bays at all times.

Installation Options

There are two ways in which the OmniSwitch 6800 Series switches can be installed:

- Tabletop installation
- Rack-mount installation

Installing the Switch on a Tabletop or Bench

OmniSwitch 6800 Series switches can be installed freestanding as tabletop units. Place your switch on a stable, flat, static-free surface.

Note. OmniSwitch 6800 Series switches must be placed “right side up.” Never attempt to operate a switch positioned on its side.

Tabletop Mounting Steps

To install the switch as a tabletop unit, follow the steps below:

- 1** Position the chassis on the table or bench where it is to be installed.
- 2** Be sure that adequate clearance has been provided for chassis airflow and access to the front, back, and sides of the switch. For recommended clearances, refer to [page 2-16](#). Also, be sure that you have placed the chassis within reach of all required AC power sources.
- 3** If you are installing a single (i.e., stand-alone) switch, continue to “[Booting OmniSwitch 6800 Series Switches](#)” on [page 2-25](#) for additional setup procedures.

If you are placing multiple switches in a stacked configuration, carefully stack the remaining switches, one on top of the other. Up to eight switches may be stacked to form a single virtual chassis. Be sure to maintain adequate clearance at the front, rear, left, and right side of all switches (see [page 2-16](#)). Also, be sure that you have placed all switches in the stack within reach of required AC power sources. Once the switches are stacked together, continue to “[Cabling Stacked Configurations](#)” on [page 2-22](#) for additional setup procedures.

Note. For comprehensive information on operating switches in a stacked configuration, refer to [Chapter 3, “Managing OmniSwitch 6800 Series Stacks.”](#)

Rack-Mounting the Switch

Refer to the important guidelines below before installing the OmniSwitch 6800 Series chassis in a rack.

- It is recommended that two people install the switch in the rack—one person to hold the chassis and position it in the rack, and a second person to secure the chassis to the rack using attachment screws (not supplied).
- Alcatel-Lucent provides two rack-mount flanges with each OmniSwitch 6800 Series switch. These flanges support standard 19-inch rack mount installations. These flanges must be attached to the chassis before the switch can be rack mounted.

Note. If you are installing the switch in a 23-inch wide rack, Alcatel-Lucent offers optional 23-inch rack-mounting hardware. For more information, contact your Alcatel-Lucent representative.

- Alcatel-Lucent does not provide rack-mount screws. Use the screws supplied by the rack vendor.
- To prevent a rack from becoming top heavy, it is recommended that you install heavier equipment at the bottom of the rack whenever possible.
- If you are installing the switch in a relay rack, be sure to install and secure the rack per the rack manufacturer's specifications.
- Review [page 2-16](#) for important chassis airflow and access recommendations before installing.

Rack Mounting Steps

To rack-mount the switch, follow the steps below:

- 1** Align the holes in the provided rack-mount flanges with the four threaded holes in the OmniSwitch 6800 Series chassis. These threaded holes are located in the left and right sides of the chassis, near the front panel.
- 2** Attach the flanges to the chassis using the provided Phillips-head screws. Be sure to tighten each of the screws firmly using a Phillips screwdriver.

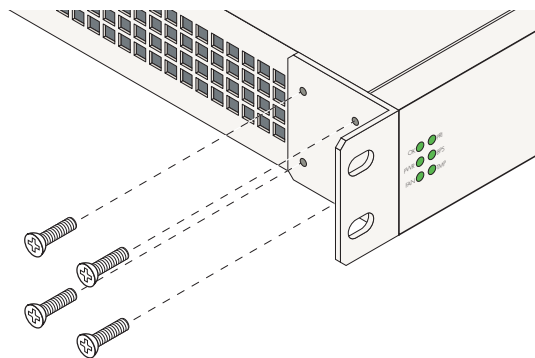

Attaching a Rack-Mount Flange

- 3 After the rack-mount flanges are secured to the chassis, mark the holes on the rack where the switch is to be installed.
- 4 Lift and position the switch until the rack-mount flanges are flush with the rack post.
- 5 Align the holes in the flanges with the rack holes that were marked in step 3.
- 6 Once the holes are aligned, insert a rack mount screw (not provided) through the *bottom hole of each flange*. Tighten both screws until they are secure.

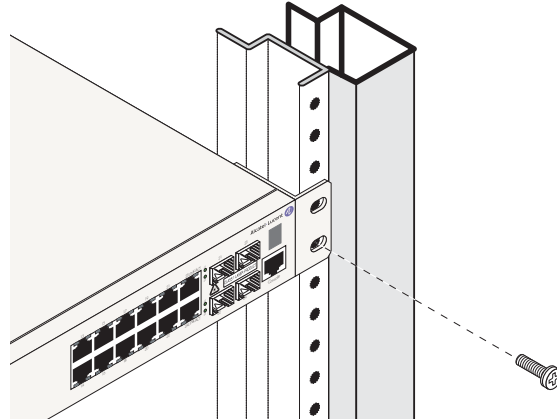

Attaching the Switch to the Rack

Note. Be sure to install the screws in the *bottom hole* of each flange, as shown, before proceeding.

- 7 Once the screws at the bottom of each flange are secure, install the remaining two rack mount screws. Be sure that all screws are securely tightened.

Note. If you are installing multiple switches in a rack to form a stacked configuration, refer to [“Setting Up a Stacked Configuration” on page 2-22](#).

Installing and Removing Combo Port SFPs

OmniSwitch 6800 Series switches offer four Gigabit Ethernet combo ports, located on the front panel (see [page 2-3](#) and [page 2-5](#)). These combo ports support hot-swappable fiber Small Form-Factor Pluggables (SFPs). For instructions on installing and removing combo port SFPs, refer to the instruction card provided with the SFP product.

Note. Combo port preferences are user-configurable via the system software. Refer to the “Configuring Ethernet Ports” in the *OmniSwitch 6800 Series Network Configuration Guide* for complete details.

Setting Up a Stacked Configuration

Rack Mounting Stacked Configurations

To rack mount a stacked configuration, install *all switches* that are to be included in the stacked configuration as described on pages 2-20 through 2-21. Up to eight switches may be stacked to form a single virtual chassis.

Note. When rack mounting multiple switches in a stacked configuration, be sure to place all switches in vertically-adjacent rack positions. This will ensure that all required stacking cables will have adequate length for the installation.

Important Note. OmniSwitch 6800-U24 switches do not support stacking.

Cabling Stacked Configurations

In order to connect stacked switches into a virtual chassis, all modules in the stack must be connected via stacking cables (provided).

Redundant Stacking Cable Connections

In addition to the stacking cables installed between adjacent switch, the top-most switch and bottom-most switch in the stack must be connected using a redundant stacking cable. Refer to [Chapter 3, “Managing OmniSwitch 6800 Series Stacks”](#) for more information on the redundant stacking cable connection.

Supported Cabling Patterns

Each switch provides two stacking ports: stacking port A and stacking port B. Cables can be connected in any pattern. In other words, the cable connected to stacking port A of one switch can be connected to either stacking port A or stacking port B of the adjacent switch. However, it is strongly recommended that the cabling pattern remains consistent across the stack. For a cabling diagram and additional information on cabling the stack, refer to [Chapter 3, “Managing OmniSwitch 6800 Series Stacks.”](#)

Cabling Steps

1 Before inserting a stacking cable into one of the stacking ports, be sure to orient the stacking cable connector properly. The wide portion of the connector must be facing up. Refer to the diagram below for more information.



When orienting the stacking cable connector, be sure that the wider portion of the connector is facing up, as shown. Otherwise, the stacking cable will not fit properly in the chassis' stacking port.

End View of Stacking Cable Connector

- 2 Starting from the top of the stack, insert one end of the stacking cable into either stacking port A or stacking port B. The stacking port (A or B) depends on your preferred cabling pattern. Refer to [Chapter 3, “Managing OmniSwitch 6800 Series Stacks”](#) for detailed information on cabling patterns. Be sure that cable connector is completely inserted and fully seated in the chassis.
- 3 Insert the other end of the stacking cable into the stacking port of the switch immediately below. Once again, the stacking port (A or B) depends on the preferred cabling pattern.
- 4 Repeat this procedure until all switches in the stack are connected (see illustrations a, b, and c below).

Reminder. The diagram below shows one supported stacking cable pattern. For additional supported cabling patterns, refer to [Chapter 3, “Managing OmniSwitch 6800 Series Stacks.”](#)

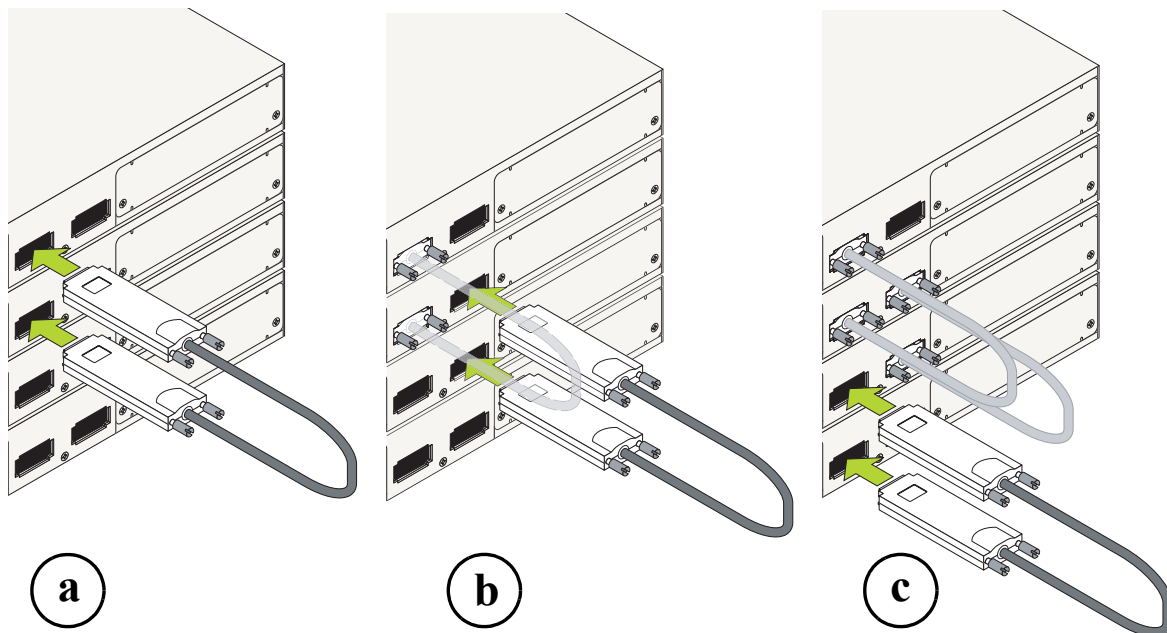

Connecting the Switches in the Stack

5 To provide added resiliency and redundancy, *you must install the redundant stacking cable* to connect the top switch in the stack to the bottom switch. Connect the redundant cable now. Refer to the diagram below for more information.

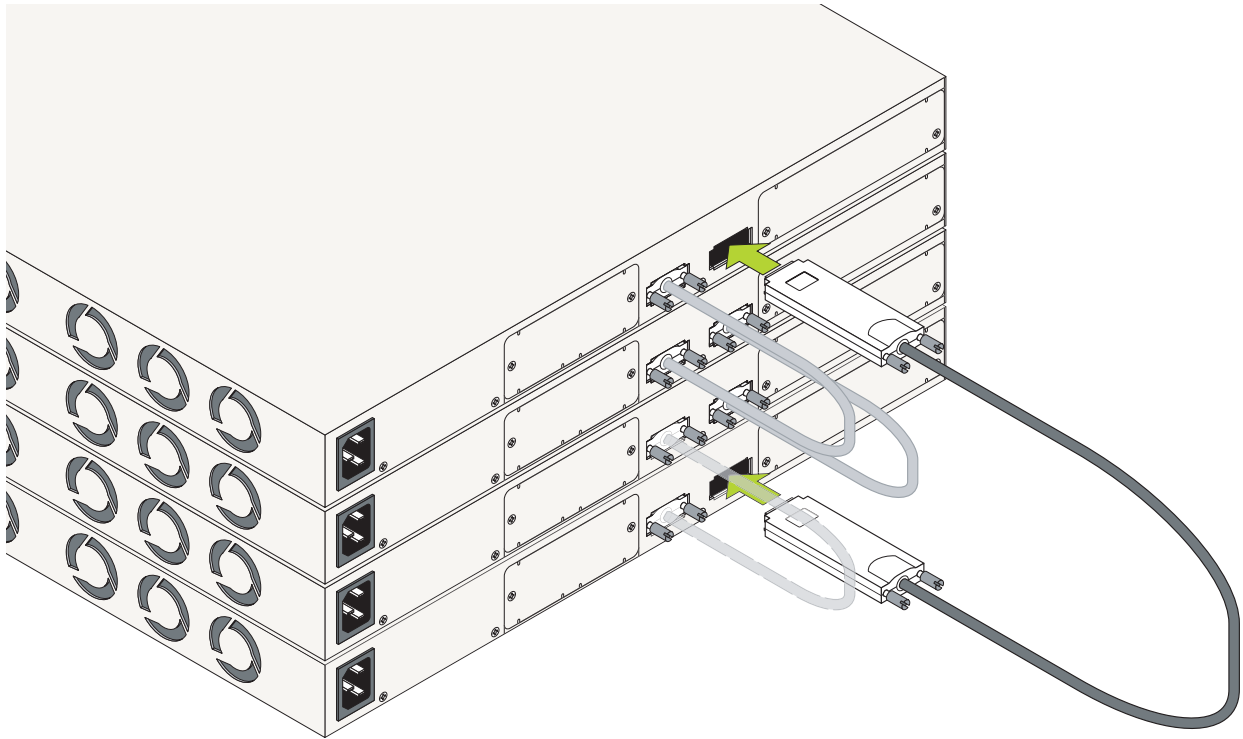

Redundant Connection Between Top and Bottom Switches

6 Once all stacking cable connectors are inserted, tighten the captive screws at the left- and right-hand sides of each connector, as shown. *Be sure not to overtighten the screws.*

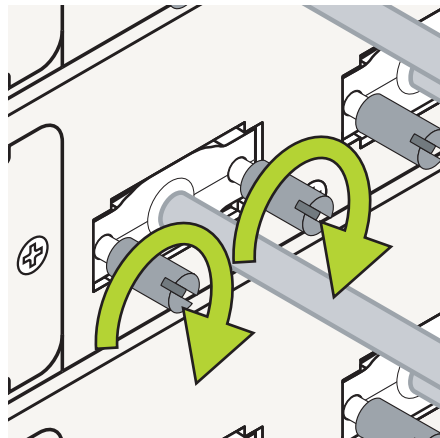

Tightening Stacking Connector Captive Screws

7 Now that all switches in the stack are connected, continue to [“Booting OmniSwitch 6800 Series Switches”](#) on page 2-25.

Booting OmniSwitch 6800 Series Switches

For information on booting stand-alone switches and switches in stacked configurations, refer to the sections below.

Booting a Stand-alone Switch

The OmniSwitch 6800 Series switch does not use an on/off switch. The power cord is the switch's only connect/disconnect device. The power connector socket is located on the switch's rear panel. For more information, refer to [“Rear Panel” on page 2-15](#).

To boot the switch, plug the power cord (provided) into the power connector socket at the switch's rear panel. Next, plug the power cord into an easily-accessible power source, such as a grounded AC outlet or an Uninterruptible Power Supply (UPS).

The switch immediately begins the boot process. Allow a few moments for the switch to boot completely, then verify the status of all LEDs on the switch's front panel. A successful boot for a stand-alone switch displays the following LED states:

LED States for a Stand-alone Switch	
OK	Solid green
PRI	Solid green
PWR	Solid green
BPS	Solid amber if no operational backup power supply (BPS) is attached; solid green if an operational BPS is attached. See page 2-40 for more information.
FAN	Solid green
TMP	Solid green
XFP1	Off (applies to all OmniSwitch 6800 Series switches except for the OmniSwitch 6800-24 and OmniSwitch 6800-24L)
XFP2	Off (applies to all OmniSwitch 6800 Series switches except for the OmniSwitch 6800-24 and OmniSwitch 6800-24L)
Slot Indicator	1–8 (non-blinking), depending on the slot number value in the <code>boot.slot.cfg</code> file. See Chapter 3, “Managing OmniSwitch 6800 Series Stacks” for detailed information. The default value is 1.

If any of the LED state differs from the states shown in the table above, refer to [page 2-13](#) for more information. Contact Alcatel-Lucent Customer Support if the LED state persists.

For information on logging in and configuring your OmniSwitch 6800 Series switch, refer to the *OmniSwitch 6800 Series Getting Started Guide* and *OmniSwitch 6800 Series Switch Management Guide*.

Booting Stacked Configurations

Once the switches have been connected into a virtual chassis, the next step is to manually power on the stack. The OmniSwitch 6800 Series switch does not use an on/off switch. The power cord is the switch's only connect/disconnect device. The power connector socket is located on the switch's rear panel. For more information, refer to [“Rear Panel” on page 2-15](#).

To boot the stack, plug the power cord (provided) into the power connector socket at the rear panel of each switch in the stack. Next, plug all power cords, in rapid succession, into easily-accessible power sources, such as grounded AC outlets or an Uninterruptible Power Supply (UPS).

Note. Be sure to power on all switches in the stack in *rapid succession*; otherwise, switches may be assigned unintended stack management roles. Refer to [Chapter 3, “Managing OmniSwitch 6800 Series Stacks”](#) for detailed information.

The stack immediately begins the boot process. Allow a few moments for all elements in the stack to boot completely, then verify the status of all LEDs on the switch's front panel. A successful boot for a stand-alone switch displays the following LED states.

LED States for a Stacked Configuration

OK	Solid green for all switches
PRI	Solid green for the primary management module; solid amber for the secondary management module; off for switches operating in idle roles. Detailed information for primary, secondary, and idle roles is provided in Chapter 3, “Managing OmniSwitch 6800 Series Stacks.”
PWR	Solid green for all switches
BPS	Solid amber for any switch <i>without</i> an operational backup power supply (BPS) attached; solid green for any switch <i>with</i> an operational BPS attached; See page 2-40 for more information.
FAN	Solid green for all switches
TMP	Solid green for all switches
XFP1	Off for all switches (applies to all OmniSwitch 6800 Series switches except for the OmniSwitch 6800-24 and OmniSwitch 6800-24L)
XFP2	Off for all switches (applies to all OmniSwitch 6800 Series switches except for the OmniSwitch 6800-24 and OmniSwitch 6800-24L)
Slot Indicator	1–8 (non-blinking), depending on the slot number assignment for each corresponding switch. See Chapter 3, “Managing OmniSwitch 6800 Series Stacks” for detailed information.

If any of the LED state differs from the states shown in the table above, refer to [page 2-13](#) for more information. Contact Alcatel-Lucent Customer Support if the LED state persists. For information on logging in and configuring your OmniSwitch 6800 Series stack, refer to the *OmniSwitch 6800 Series Getting Started Guide* and *OmniSwitch 6800 Series Switch Management Guide*.

Note. Chapter 3, “[Managing OmniSwitch 6800 Series Stacks](#),” provides important information on virtual chassis behavior during and after a boot. Consulting this chapter is strongly recommended for users operating switches in a stacked configuration.

Power Cords

Because the power cord is the switch’s only disconnect device, it should be plugged into an easily accessible outlet. In the event that your power cord is lost or damaged, refer to the specifications below.

Specifications

The power cord to be used with 115-Volt configuration is a minimum type SJT (SVT) 18/3, rated at 250 Volts AC, 10 Amps with a maximum length of 15 feet. One end terminates in an IEC 320 attachment plug and the other end terminates in a NEMA 5-15P plug.

The power cord to be used with 230-Volt configuration is minimum type SJT (SVT) 18/3, rated 250 Volts AC, 10 Amps with a maximum length of 15 feet. One end terminates in an IEC 320 attachment plug and the other end terminates as required by the country where it will be installed.

European cords must be Harmonized (HAR) type. Refer to the information below for power plug types by region:

Power Cord Types	
North America	NEMA 5-15-P (US), C22.2, No. 42 (Canada)
United Kingdom / Ireland	BS 1,363
Europe	CEE 7/7
Japan	JIS 8,303
Australia	AS 3,112
India	BS 546
Italy	CIE 2,316
Switzerland / Liechtenstein	SEV 1011
Denmark / Greenland	SRAF 1,962 / D816 / 87
Argentina	AR1-10P

Console Port

The console port, located on the chassis front panel, provides a console connection to the switch and is required when logging into the switch for the first time. By default, this RJ-45 connector provides a DTE console connection.

Serial Connection Default Settings

The factory default settings for the serial connection are as follows:

baud rate	9600
parity	none
data bits (word size)	8
stop bits	1
flow control	none

Modifying the Serial Connection Settings

The switch's serial connection defaults are listed above. If you wish to modify the default serial connection settings (i.e., baud rate, parity, data bits, and stop bits), refer to the following steps:

Note. You must be connected to the switch via the console port before attempting to change serial connection settings. Otherwise, an error message will display.

For switches in a stacked configuration, all changes must be configured before the switches are cabled together. In other words, you must configure these settings when each switch is operating as a stand-alone unit.

-
- 1 Enter the **modify boot parameters** command at the CLI prompt. The boot prompt displays:

```
Boot >
```

- 2 To change the baud rate, enter **boot serialbaudrate**, followed by the desired baud rate value. Options include 1200, 2400, 4800, 9600 (default), 19200, 38400, 57600, 76800, and 115200. For example:

```
Boot > boot serialbaudrate 19200
```

Note. Setting the console port to speeds above 9600 baud can cause problems with Zmodem uploads.

- 3 To change the parity value, enter **boot serialparity**, followed by the desired parity value. Options include none (default), even, and odd. For example:

```
Boot > boot serialparity even
```

- 4 To change the data bits (i.e., word size) value, enter **boot serialwordsize**, followed by the number of data bits. Options include 7 and 8 (default). For example:

```
Boot > boot serialwordsize 7
```

- 5** To change the stop bits value, enter **boot serialstopbits**, followed by the number of stop bits. Options include 1 (default) and 2. For example:

```
Boot > boot serialstopbits 2
```

- 6** Verify your current changes by entering **show** at the boot prompt:

```
Boot > show
Edit buffer contents:
Serial (console) baud      : 19200
Serial (console) parity   : even
Serial (console) stopbits  : 2
Serial (console) wordsize : 7
```

(additional table output not shown)

- 7** You can save your changes to the **boot.params** file by entering **commit file** at the boot prompt:

```
Boot > commit file
```

When the **commit file** command is used, changes will not be enabled until after the next switch reboot.

- 8** You can also save your changes in real time to the switch's running memory by entering **commit system** at the boot prompt:

```
Boot > commit system
```

Caution. There are two important things to consider when using the **commit system** command to save serial connection changes:

- Output to the terminal may become illegible due to incompatible serial connection settings between the switch and the terminal emulation software.
- If you use the **commit system** command only, changes will *not* be saved to the switch's **boot.params** file and will be lost if the switch is rebooted. To save changes to the **boot.params** file, refer to step 7.

-
- 9** Return to the CLI prompt by entering **exit** at the boot prompt.

Console Port Pinouts

RJ-45 Console Port – Connector Pinout

Pin Number	Signals as DTE Console Port
1	NC
2	NC
3	RXD
4	Ground
5	Ground
6	TXD
7	NC
8	NC

Monitoring the Chassis

OmniSwitch 6800 Series switches can be monitored and managed via the console port using Command Line Interface (CLI) commands. The switches can also be monitored and managed via the Ethernet ports using CLI commands, WebView, SNMP, and OmniVista.

The section below provides some examples of useful hardware-related monitoring CLI commands. Refer to the *OmniSwitch CLI Reference Guide* for detailed information on all management and monitoring commands used with the OmniSwitch 6800 Series switch. For comprehensive information on managing and monitoring *stacked configurations*, refer to [Chapter 3, “Managing OmniSwitch 6800 Series Stacks.”](#)

Checking Overall Chassis Status

To check the overall status of a chassis, including the chassis type, and current administrative and operational status, use the **show chassis** command. For example:

```
-> show chassis
```

```
Chassis 1
  Model Name:           OS6800-48,
  Description:          10/100/1000,
  Part Number:          902274-10,
  Hardware Revision:    005,
  Serial Number:        439L0024,
  Manufacture Date:     SEP 22 2004,
  Admin Status:         POWER ON,
  Operational Status:   UP,
  Number Of Resets:     1
```

When the **show chassis** command is issued for a stacked configuration, status information for all switches in the stack displays. For a complete list of output definitions for this command, refer to the *OmniSwitch CLI Reference Guide*.

Checking Temperature Status

To check chassis temperature status, including the current temperature and configured threshold values, use the **show temperature** command. For example:

```
-> show temperature
```

```
Temperature for chassis 1
  Hardware Board Temperature (deg C)      = 38,
  Hardware Cpu Temperature (deg C)       = N/A,
  Temperature Upper Threshold Range (deg C) = 30 to 72,
  Temperature Upper Threshold (deg C)    = 57,
  Temperature Range                       = UNDER THRESHOLD,
  Temperature Danger Threshold (deg C)    = 72
```

When the **show temperature** command is issued for a stacked configuration, status information for all switches in the stack displays. For a complete list of output definitions for this command, refer to the *OmniSwitch CLI Reference Guide*.

Checking Fan Status

To check the current status for all six fans in the chassis, use the **show fan** command. For example:

```
-> show fan
Chassis Fan  Status
-----+---+-----
      1      1  Running
      1      2  Running
      1      3  Running
      1      4  Running
      1      5  Running
      1      6  Running
```

When the **show fan** command is issued for a stacked configuration, status information for all switches in the stack displays. For a complete list of output definitions for this command, refer to the *OmniSwitch CLI Reference Guide*.

Checking Power Supply Status

For information on checking power supplies for stand-alone and stacked OmniSwitch 6800 Series switches, refer to [“Viewing Primary and Backup Power Supply Status” on page 2-53](#).

Additional Monitoring Commands

CLI Commands Used for Monitoring a Chassis

show cmm	Displays basic hardware and status information for primary and secondary management modules (if applicable).
show ni	Displays basic hardware and status information for individual modules. If the switch is a stand-alone, information for the stand-alone switch displays.
show module	Displays basic information for individual modules. If the switch is a stand-alone, information for the stand-alone switch displays.
show module long	Displays detailed information for individual modules. If the switch is a stand-alone, information for the stand-alone switch displays.
show module status	Displays basic status information for individual modules. If the switch is a stand-alone, information for the stand-alone switch displays.

Using LEDs to Visually Monitor the Chassis

The front panel of OS6800-24 and OS6800-48 switches provides status LEDs that are useful in visually monitoring the status of stand-alone switches, as well as switches stacked into a virtual chassis. Front panel LEDs include:

- Ethernet Port LEDs
- Slot Indicator LED
- System Status LEDs
- Combo Port Status LEDs

For tables showing LED states for switches and stacks operating normally, refer to pages [2-25](#) and [2-26](#). For detailed information on all OmniSwitch 6800 Series LEDs, refer to [page 2-13](#).

OS6800-XNI-U2 10 Gigabit Expansion Module

OmniSwitch 6800-48, 6800-U24, and 6800-48L switches support a 10 Gigabit expansion module (OS6800-XNI-U2). The slot for the expansion module is located at the rear panel of the switch chassis. The 10 Gigabit Ethernet expansion module supports up to two 10 Gbps Small Form Factor Pluggable (XFP) optical transceivers. XFPs are ordered separately and are available for short-reach and long-reach applications. (See [page 2-39](#) for more information on XFPs.)

Important. The OS6800-XNI-U2 10 Gigabit expansion module *cannot* be hot swapped. Attempting to hot swap the expansion module will result in a reboot of the switch and may interrupt network data flow.

XFP Connectors

The OS6800-XNI-U2 module provides two ports for 10 Gbps Small Form Factor Pluggable (XFP) transceivers. For additional information on XFPs, refer to [page 2-39](#).

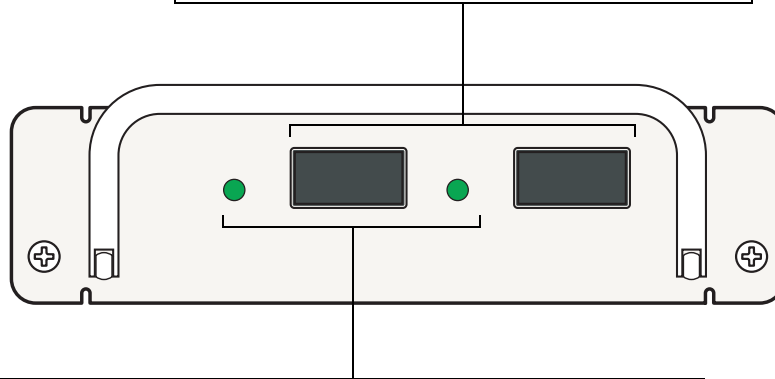

XFP Status LEDs

The 10 Gigabit expansion module provides two LEDs (XFP1 and XFP2) for monitoring XFP link status and activity. Each LED displays solid green when its corresponding port is up; each LED blinks green when the corresponding port is transmitting or receiving packets in a link up state. The LEDs are off when no link is detected.

Note that OmniSwitch 6800-48, 6800-U24, and 6800-48-L switches provide XFP status LEDs on the chassis front panel for easier visibility. The function of chassis front panel LEDs is identical to the LEDs included on the expansion module.

10 Gigabit Expansion Module Front Panel

10 Gigabit Expansion Module Specifications

Number of ports	2
Power consumption	16W (with two XFPs installed)
Data Speed	Approximately 10.3 Gbps (per port)
Transceiver Type Supported	XFP
Chassis port locations	49 and 50 (OS6800-48, OS6800-48L); 25 and 26 (OS6800-U24)

10 Gigabit Slot and Port Numbering

Slot Numbering

The slot number for the 10 Gigabit expansion module is defined by the position of the OS6800 chassis in a stacked configuration. For example, if a switch is assigned slot 3, an expansion module installed in the same chassis is also designated slot 3. For stand-alone switches, the default slot number is 1.

To verify a switch's current slot number, refer to the slot number LED on the chassis front panel or issue the **show module long** command and locate the module with the relevant 10 Gigabit expansion module installed.

Port Numbering

The port numbers for the 10 Gigabit expansion module are defined by a switch's chassis type. 10 Gigabit ports installed in OS6800-48 and OS6800-48L switches are assigned port numbers 49 and 50; 10 Gigabit ports installed in OS6800-U24 switches are assigned port numbers 25 and 26.

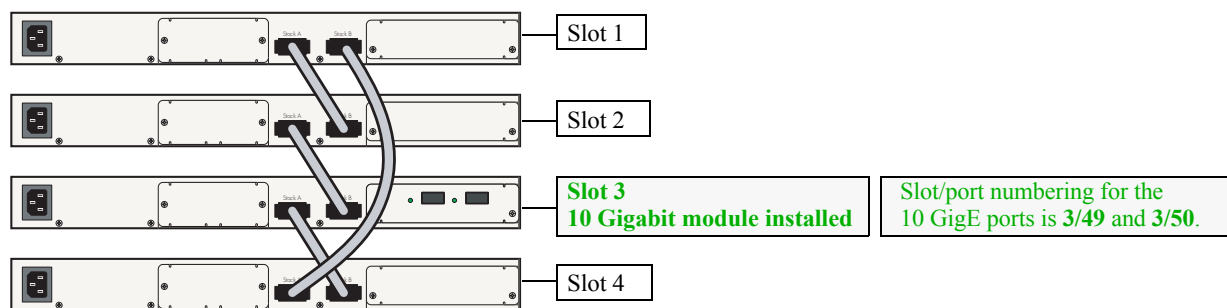

In this example diagram, OS6800-48/OS6800-48L chassis types are shown. The OS6800-U24 chassis does not support stacking.

Expansion Module Slot/Port Numbering Example

10 Gigabit Expansion Modules and Token Usage

As with OmniSwitch 6800 and OmniSwitch 6800L switches, 10 Gigabit expansion modules also use tokens for budgeting stack ASIC resources. Each expansion module operating within a stack uses two tokens. No more than five expansion modules can operate within a stack of OS6800 or OS6800-L switches at any time.

Refer to the “Managing OmniSwitch 6800 Series Stacks” chapter for more information on tokens.

10 GigE Interoperability Between OS6800 and OS8800 Switches

In order to have 10 Gigabit uplink operability between OS6800 and OS8800 switches, users must issue the **bridge port 10gig os8800optimized** command on the OS6800 switch. The command must be issued separately for each 10 Gigabit port. The following examples show operability being enabled on both 10 Gigabit ports installed in an OS6800-U24 chassis:

```
-> bridge port 1/25 10gig os8800optimized enable
-> bridge port 1/26 10gig os8800optimized enable
```

For more information on specifying 10 Gigabit slot and port numbers, refer to [“10 Gigabit Slot and Port Numbering” on page 2-35](#).

Note. The **bridge port 10gig os8800optimized** command applies *only* to OS6800-48, OS6800-48L, and OS6800-U24 switches being connected to OS8800 switches via a 10 Gigabit uplink. For more information on this command, refer to the *CLI Reference Guide*.

Viewing Interoperability Status

To view whether a 10 Gigabit port has been optimized for use with OS8800 switches, use the **show spantree ports** command. Be sure to include the keyword **configured** in the command line. For example:

```
-> show spantree 1 ports configured
Spanning Tree Port Admin Configuration for Vlan 1
      Port  Adm Man.  Config  Adm  OS8800
Port  Pri   St.  Mode   Cost  Cnx  10G Opt.
-----+-----+-----+-----+-----+-----+-----
1/1    7   ENA  No      0  AUT  DIS
1/2    7   ENA  No      0  AUT  DIS
1/3    7   ENA  No      0  AUT  DIS
1/4    7   ENA  No      0  AUT  DIS
1/5    7   ENA  No      0  AUT  DIS
1/6    7   ENA  No      0  AUT  DIS
1/7    7   ENA  No      0  AUT  DIS
1/8    7   ENA  No      0  AUT  DIS
1/9    7   ENA  No      0  AUT  DIS
1/10   7   ENA  No      0  AUT  DIS
1/11   7   ENA  No      0  AUT  DIS
1/12   7   ENA  No      0  AUT  DIS
1/13   7   ENA  No      0  AUT  DIS
1/14   7   ENA  No      0  AUT  DIS
1/15   7   ENA  No      0  AUT  DIS
1/16   7   ENA  No      0  AUT  DIS
1/17   7   ENA  No      0  AUT  DIS
1/18   7   ENA  No      0  AUT  DIS
1/19   7   ENA  No      0  AUT  DIS
1/20   7   ENA  No      0  AUT  DIS
1/21   7   ENA  No      0  AUT  DIS
1/22   7   ENA  No      0  AUT  DIS
1/23   7   ENA  No      0  AUT  DIS
1/24   7   ENA  No      0  AUT  DIS
1/25   7   ENA  No      0  AUT  ENA
1/26   7   ENA  No      0  AUT  ENA
```

10 Gigabit/OS8800 optimization is shown enabled on both 10 Gigabit ports in the chassis (an OS6800-U24 in this case).

Installing 10 Gigabit Expansion Modules

ESD Caution. Before handling the expansion module, you must discharge all static electricity on your person to avoid Electrostatic Discharge (ESD) damage. If using a wrist strap, ensure that the wrist strap touches your skin. Attach the other end of the strap to the chassis.

- 1 If there is a blank cover panel installed over the expansion module slot position, uninstall it by removing the two Phillips attachment screws. After the attachment screws have been removed, carefully pry the blank cover panel out and away from the chassis. Set the cover panel and attachment screws aside.
- 2 Holding the expansion module by the front panel, carefully slide the circuit board into the card guide located in the chassis slot.

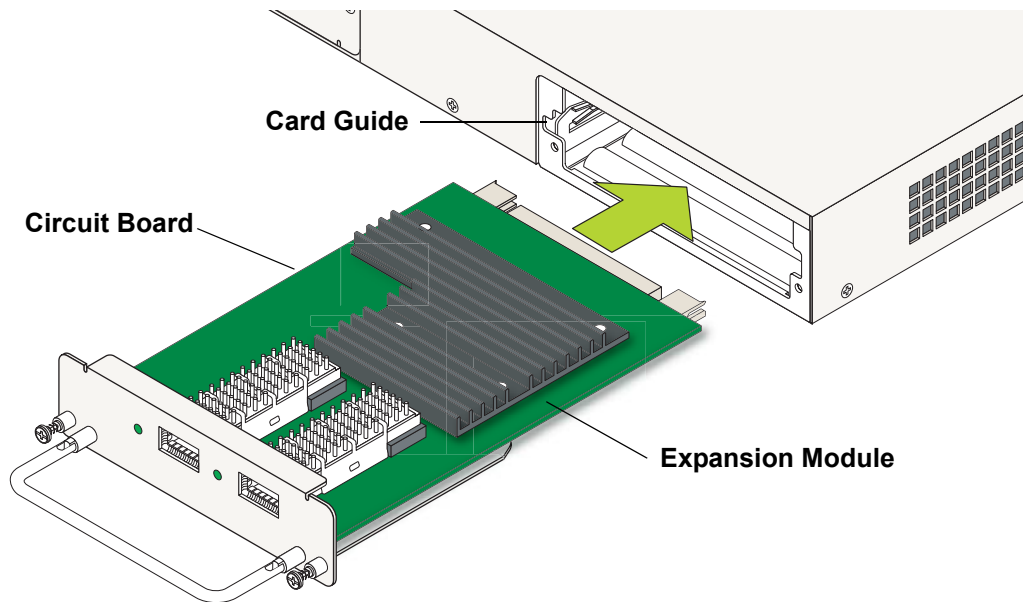

Inserting the 10 Gigabit Expansion Module

Note. The module should slide in easily. Do not force the module into the slot. If any resistance is encountered, ensure that the module is aligned properly in the card guide and try again.

- 3 Slide the module back until the backplane connector is inserted in the chassis backplane; the module's front panel should be flush with the front of the chassis. *Do not force the module into the slot. Forcing the module can damage the connectors.*
- 4 Once the module is firmly seated and flush with the chassis front panel, secure the module by tightening the two captive screws. *Be sure not to overtighten the captive screws. If using a screwdriver, the torque used to tighten the screws must not exceed 2.3 foot-pounds.*

Removing 10 Gigabit Modules

To remove an expansion module from the chassis, follow the steps below:

ESD Caution. Before handling the expansion module, you must discharge all static electricity on your person to avoid Electrostatic Discharge (ESD) damage. If using a wrist strap, ensure that the wrist strap touches your skin. Attach the other end of the strap to the chassis.

1 Loosen the two captive screws, located at the left and right sides of the module's front panel. If necessary, use a Phillips screwdriver to loosen the screws.

Note. Be sure that both captive screws are completely disengaged from the threaded holes in the chassis before continuing.

2 Once the captive screws are completely disengaged, grasp the handle and slowly pull the module out of the slot.

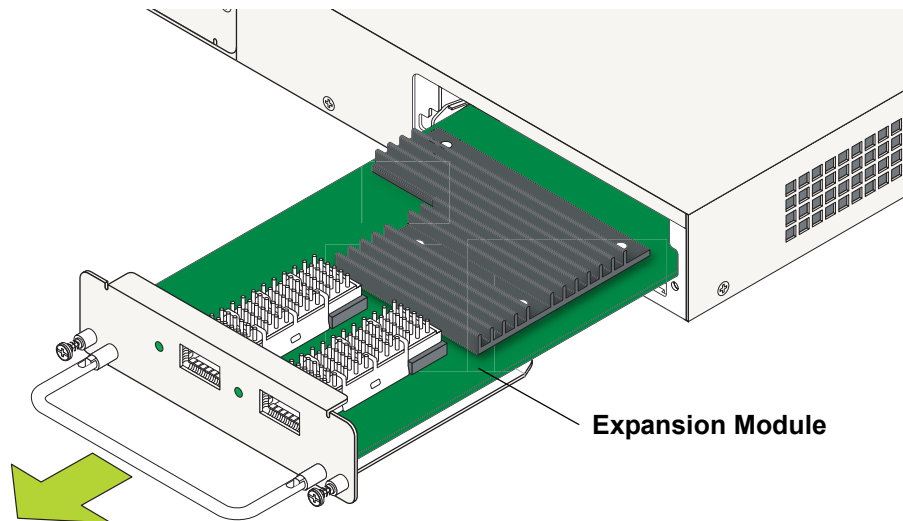

Removing the 10 Gigabit Expansion Module

3 Store the module in a secure location. Placing the module in an anti-static bag is recommended.

Blank Cover Panel Requirement

If you are not replacing the expansion module being removed, be sure to install a blank cover panel (supplied with your switch) over the empty module slot. To install a blank cover panel, follow the steps below:

1 Slide the blank cover panel into the empty slot and insert two Phillips screws (also supplied with the switch) through the panel and into the threaded holes in the chassis.

2 Once the screws are inserted, fasten the panel to the chassis by tightening the screws. *Be sure not to overtighten the screws.*

Installing SFP and XFP Transceivers

For information on installing XFPs and SFPs, refer to the instruction card included with the transceiver.

Backup Power Supply Components

OmniSwitch 6800 Series switches support optional backup power supply components. Components include:

- OS6800-BPS-SHLF backup power supply shelf
- OS6800-BPS 225W backup power supply module
- Backup power supply daughtercard
- Backup power supply connector cable

When backup power supply components are installed, the primary (factory-installed) power supply continues to take on the full power load for switch operations. Meanwhile, the backup power supply operates in *active standby* mode. If the primary power supply fails unexpectedly, the backup power supply automatically takes up the full power load without disrupting the switch.

Because the OmniSwitch 6800 Series backup power supply system is chassis-based—with each chassis supporting up to eight backup power supplies—this provides 1:1 redundancy for stacks of up to eight switches.

OS6800-BPS-SHLF Backup Power Supply Shelf

The OS6800-BPS-SHLF backup power supply shelf is a separate, rack-mountable chassis offering power supply bays for up to eight 225 watt power supply modules. Each module can be connected to a single OmniSwitch 6800 Series switch—either stand-alone or in a stacked configuration. Refer to the sections below for more information.

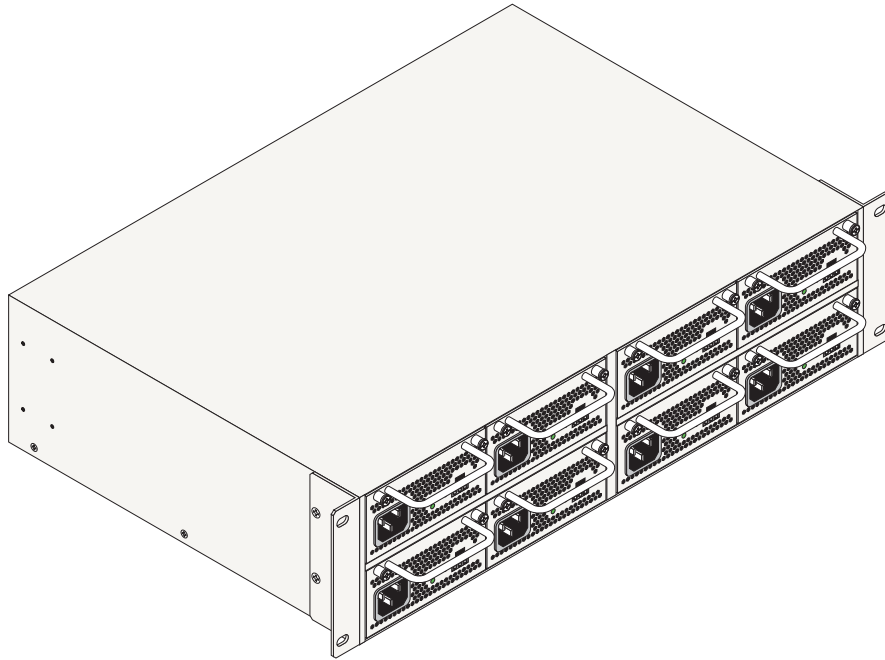

OS6800-BPS-SHLF Backup Power Supply Shelf

OS6800-BPS-SHLF Backup Power Shelf Specifications

The table below lists the specifications for the OS6800-BPS-SHLF Backup Power Shelf:

OS6800-BPS-SHLF Backup Power Shelf Specifications	
Width (rack-mount flanges not included)	17.32 inches, approx.
Width (including rack-mount flanges)	19.125 inches, approx.
Height	4.325 inches, approx.
Height (rack units)	2.5 RU
Depth	12 inches, approx.
Ambient Temperature	0 to +45 deg C, operating; -20 to +70 deg C, storage
Humidity	5% to 90% Relative Humidity (Operating) 0% to 95% Relative Humidity (Storage)

Important Note. The OS6800-BPS-SHLF power shelf is an accessory product and can be used only with the OmniSwitch 6800 Series product. Do not attempt to operate the OS6800-BPS-SHLF power shelf with any other product or chassis type.

OS6800-BPS-225 225W Backup Power Supply

Up to eight OS6800-BPS-225 225 watt power supplies can be installed in the OS6800-BPS-SHLF power shelf. Each OS6800-BPS-225 provides backup power for one OS6800-24 or OS6800-48 switch.

Power Connector Socket.
Type IEC-320-C13. Supports one 10 amp power cord.

It is recommended that you use Alcatel-Lucent provided power cords only.

Fan Status (Top LED).
Green when the power supply fans are operating under normal conditions.

Solid amber when a fan error is detected (e.g., one or more fans quit unexpectedly).

Off when the power supply is not operating.

Power OK (Bottom LED).
Displays solid green when the power supply is operating normally.

Off when the power supply is not operating.

Power Supply LEDs

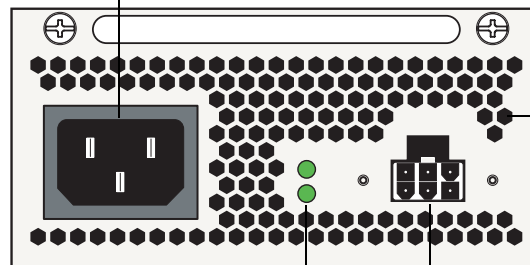

Air Intake Vent.

The air intake vent provides cooling and temperature control for the power supply. Maintain a front clearance of at least six inches to ensure proper airflow.

DC Connector Socket.

Connector socket for attaching the OS6800-BPS power supply to the OS6800-24 or OS6800-48 switch chassis.

OS6800-BPS-225 Backup Power Supply

For information on installing a backup power supply module, refer to [page 2-46](#). For information on removing a backup power supply, refer to [page 2-48](#).

OS6800-BPS-225 225W Backup Power Supply Specifications

The table below lists the specifications for the OS6800-BPS-225 backup power supply:

OS6800-BPS-225 225W Backup Power Supply Specifications	
Input Voltage	3 A @ 100-240 VAC
Input Frequency	50-60 Hz
Width	4.3 inches, approx.
Height	1.73 inches, approx.
Depth	12 inches, approx.
Ambient Temperature	0 to +45 deg C, operating; -20 to +70 deg C, storage
Humidity	5% to 90% Relative Humidity (Operating) 0% to 95% Relative Humidity (Storage)

Important Note. The OS6800-BPS backup power supply is an accessory product and can be used only with the OmniSwitch 6800 Series product. Do not attempt to operate the OS6800-BPS backup power supply with any other product or chassis type.

Rack-Mounting the OS6800-BPS-SHLF Power Shelf

Refer to the important guidelines below before installing the OS6800-BPS-SHLF power shelf in a rack.

- The power shelf can be installed with either the power supply bays or the fan vents facing out. Screw holes for rack-mount flanges are provided on either side of the power shelf. As a result, either panel can be considered the front panel, depending on the preferred installation. Note that installations in which the power supplies face out require a longer connector cable distance between the switch chassis and the power shelf. Before attempting to install the power shelf in a rack, be sure that the connector cables have adequate reach.
- It is recommended that two people install the power shelf in the rack—one person to hold the shelf and position it in the rack, and a second person to secure the shelf to the rack using attachment screws (not supplied).
- Alcatel-Lucent provides two rack-mount flanges with each OS6800-BPS-SHLF power shelf. These flanges support standard 19-inch rack mount installations. These flanges must be attached to the chassis before the power shelf can be rack mounted.

Note. If you are installing the power shelf in a 23-inch wide rack, Alcatel-Lucent offers optional 23-inch rack-mounting hardware. For more information, contact your Alcatel-Lucent representative.

- Alcatel-Lucent does not provide rack-mount screws. Use the screws supplied by the rack vendor.
- To prevent a rack from becoming top heavy, it is recommended that you install heavier equipment at the bottom of the rack whenever possible.
- If you are installing the power shelf in a relay rack, be sure to install and secure the rack per the rack manufacturer's specifications.
- Review [page 2-16](#) for important chassis airflow and access recommendations before installing.

Rack Mounting Steps

To rack-mount the power shelf, follow the steps below:

- 1** Align the holes in the provided rack-mount flanges with the four threaded holes in the power shelf. These threaded holes are located in the left and right sides of the power shelf, near the front panel.
- 2** Attach the flanges to the power shelf using the provided Phillips-head screws. Be sure to tighten each of the screws firmly using a Phillips screwdriver.

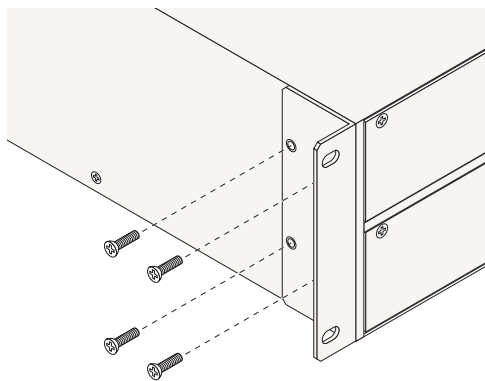

Attaching a Rack-Mount Flange

Note: The power shelf can be installed with either the power supply bays or the fan vents facing out. Screw holes for rack-mount flanges are provided on either side. This example diagram shows the an installation in which the power supply bays are facing out. Refer to the list of guidelines above for more information.

- 3** After the rack-mount flanges are secured to the power shelf, mark the holes on the rack where the power shelf is to be installed.
- 4** Lift and position the power shelf until the rack-mount flanges are flush with the rack post.
- 5** Align the holes in the flanges with the rack holes that were marked in step 3.
- 6** Once the holes are aligned, insert a rack mount screw (not provided) through the *bottom hole of each flange*. Tighten both screws until they are secure.

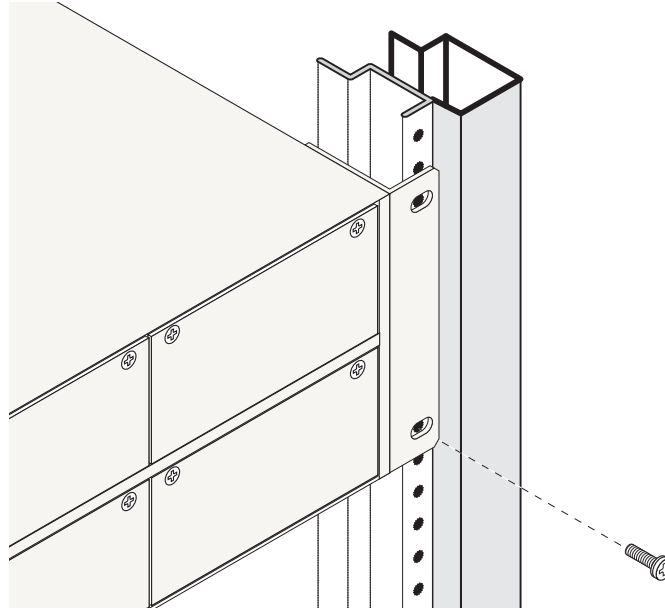

Attaching the Power Shelf to the Rack

Note. Be sure to install the screws in the *bottom hole* of each flange, as shown, before proceeding.

- 7** Once the screws at the bottom of each flange are secure, install the remaining rack mount screws. Be sure that all screws are securely tightened.

Installing a Backup Power Supply In the Power Shelf

Hot-Swapping Backup Power Supplies. Backup power supplies are fully hot-swappable. In other words, you can add a backup power supply to the power shelf at any time without disturbing the switch's network functions. You are not required to power down the switch.

Installation Steps

To add a backup power supply to the power shelf, follow the steps below:

Anti-Static Warning. Before handling any components, free yourself of static by wearing a grounding strap, or by grounding yourself properly. Static discharge can damage the switch and the backup power supply.

- 1** If there is a blank cover panel installed at the backup power supply bay, uninstall it by removing the two Phillips attachment screws. After the attachment screws have been removed, carefully pry the blank cover panel out and away from the chassis. Set the cover panel and attachment screws aside.
- 2** Be sure that you do not attempt to install the power supply upside down. When orienting the power supply, note that the power cord socket is located at the *left* of the power supply and the handle is located at the *top* of the power supply. For more information, refer to the diagram below.

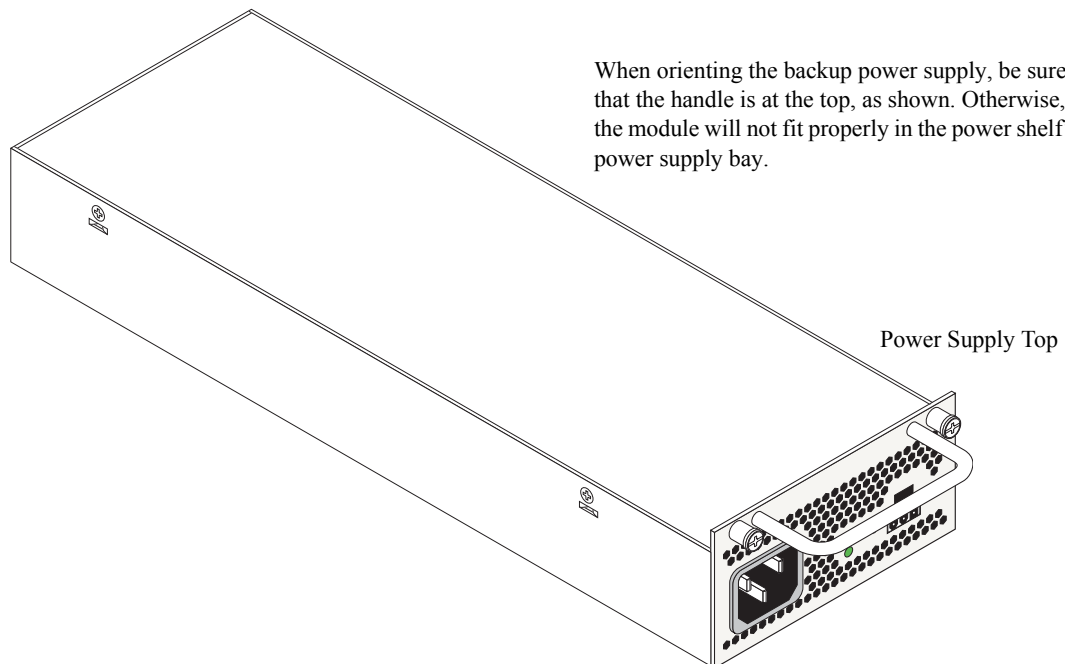

Orienting the Backup Power Supply

- 3** With one hand, grasp the handle at the front of the power supply. Place your other hand under the power supply casing to support its weight. Carefully insert the rear of the casing into the power supply bay and slide the power supply back along the chassis alignment guide until its connector meets the chassis backplane connector.

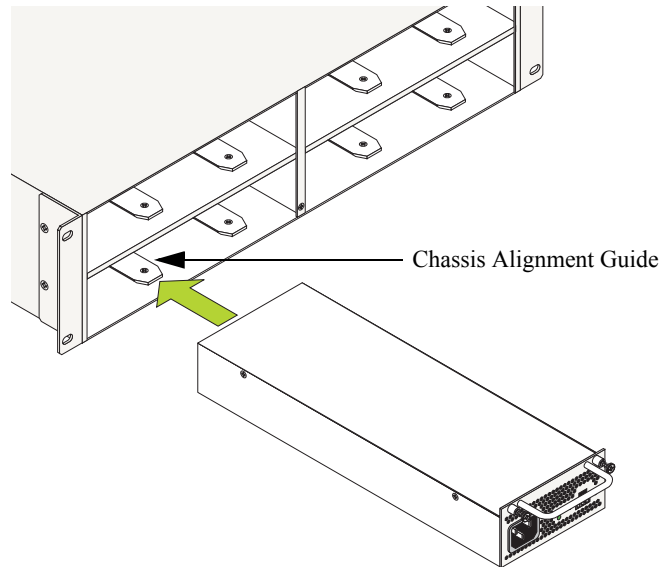

Inserting the Backup Power Supply

- 4** Continue sliding the power supply back until the front panel is flush with the rear panel of the chassis. *Do not force the power supply into the bay. Otherwise you can damage the connectors.*
- 5** Tighten the two captive screws, located at the left and right sides of the power supply's front panel. *Be sure not to overtighten the captive screws. If you use a screwdriver, the torque used to tighten the screws must not exceed 2.3 foot-pounds.*

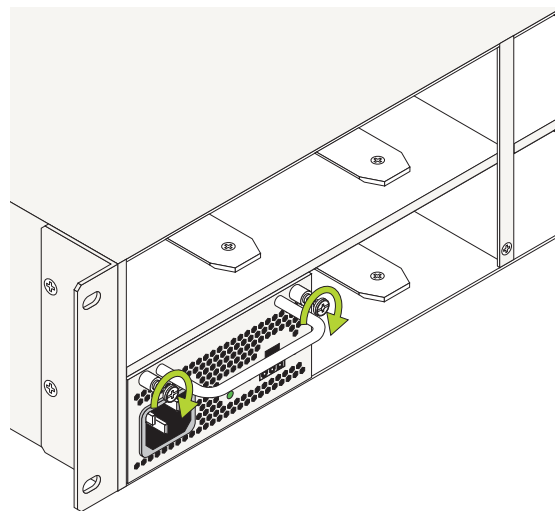

Tightening the Captive Screws

- 6** Connect the power supply cord (provided) into an easily accessible power source.

Note. If you are installing multiple backup power supplies in the power shelf, install all remaining units by repeating steps 1 through 6 for each supply.

Installing the Backup Power Supply Daughtercard

Once all backup power supplies are installed in the backup power supply shelf, be sure that a backup power supply daughtercard is installed in the rear panel of each switch that is to receive redundant power. For help locating the backup power supply daughtercard bay, refer to [“Rear Panel” on page 2-15](#).

Note. You can install a daughtercard in the chassis at any time without disturbing the switch’s network functions. You are not required to power down the switch.

Anti-Static Warning. Before handling any components, free yourself of static by wearing a grounding strap, or by grounding yourself properly. Static discharge can damage the switch and the backup power supply.

Installation Steps

To install the backup power supply daughtercard in the rear of the chassis, follow the steps below:

- 1** If there is a blank cover panel installed at the daughtercard bay, uninstall it by removing the two Phillips attachment screws. After the attachment screws have been removed, carefully pry the blank cover panel out and away from the chassis. Set the cover panel and attachment screws aside.
- 2** When orienting the daughtercard, be sure to keep the circuit board situated toward the bottom.
- 3** Carefully slide the daughtercard into the bay (located at the rear panel of the chassis—see [page 2-15](#)) until the front panel of the daughtercard is flush with the chassis rear panel and the module is seated securely.
- 4** Tighten the two captive screws located at the left and right sides of the daughtercard’s front panel. *Be sure not to overtighten the captive screws. If you use a screwdriver, the torque used to tighten the screws must not exceed 2.3 foot-pounds.*
- 5** Repeat steps 1 through 4 for any remaining switches that are to receive redundancy power supply support.

Installing the Backup Power Supply Connector Cables

Once all backup power supplies are installed in the backup power supply shelf and all daughtercards are installed in the switch chassis, connect one backup power supply connector cable between each power supply and daughtercard.

Powering on the Backup Power Supplies

OmniSwitch 6800 Series backup power supplies do not use on/off switches. The power cord is the supply’s only connect/disconnect device. The power connector socket is located on the supply’s front panel. For more information, refer to [“OS6800-BPS-225 225W Backup Power Supply” on page 2-42](#).

To power on the backup power supply, plug the power cord (provided) into the supply’s power connector socket. Next, plug the power cord into an easily-accessible power source, such as a grounded AC outlet or an Uninterruptible Power Supply (UPS). Repeat this process for each backup power supply installed in the power shelf.

Removing a Backup Power Supply

Note. You can remove a backup power supply from the power shelf at any time without disturbing the switch's network functions. You are not required to power down the switch.

Anti-Static Warning. Before handling any components, free yourself of static by wearing a grounding strap, or by grounding yourself properly. Static discharge can damage the switch and the backup power supply.

Removal Steps

To remove a backup power supply from the power shelf, follow the steps below:

Note. Before handling any components, free yourself of static by wearing a grounding strap, or by grounding yourself properly. Static discharge can damage the switch and the backup power supply.

- 1** Unplug the power cord from the AC power source, as well as from the socket located on the power supply's front panel.
 - 2** Loosen the two captive screws, located at the left and right sides of the power supply's front panel. If necessary, use a Phillips screwdriver to loosen the screws.
-

Note. Be sure that both captive screws are completely disengaged from the threaded holes in the chassis before continuing.

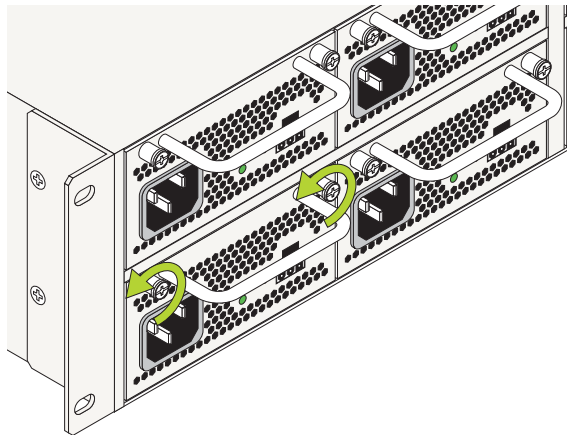

Loosening the Captive Screws

- 3 Once the captive screws are completely disengaged, grasp both captive screws and slowly pull the power supply out of the power supply bay.

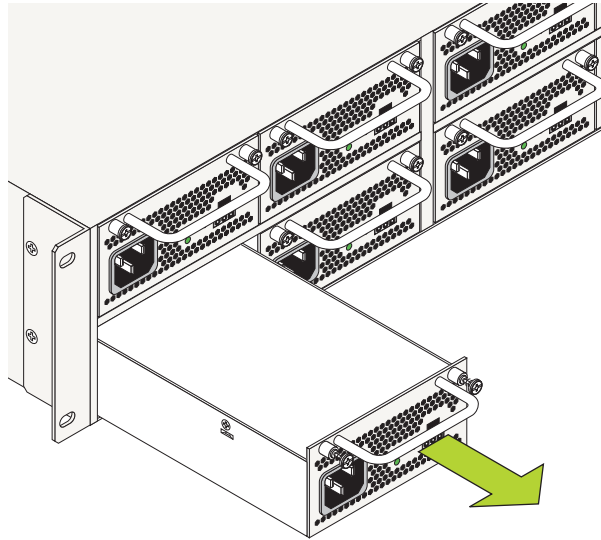

Removing the Backup Power Supply

- 4 Store the power supply in a secure, static-free location.
- 5 Refer to the important blank cover panel requirement on [page 2-51](#).

Removing the Backup Power Supply Daughtercard

Note. You can remove a daughtercard from the chassis at any time without disturbing the switch's network functions. You are not required to power down the switch.

Anti-Static Warning. Before handling any components, free yourself of static by wearing a grounding strap, or by grounding yourself properly. Static discharge can damage the switch and the backup power supply.

Removal Steps

To remove the daughtercard from the rear of the chassis, follow the steps below:

- 1 Loosen the two captive screws located at the left and right sides of the daughtercard module.
-

Note. Be sure that both captive screws are completely disengaged from the threaded holes in the chassis before continuing.

- 2 Carefully slide the daughtercard out of the bay.
- 3 Store the daughtercard in a secure, static-free location.
- 4 Refer to the important blank cover panel requirement below.

Blank Cover Panel Requirement

If you are not replacing any backup power supplies or daughtercard modules being removed, be sure to install a blank cover panel (supplied with your power shelf or switch) over the empty bays. To install a blank cover panel, follow the steps below:

- 1 Place the blank cover panel over the empty bay and insert two Phillips screws (also supplied with the power shelf or switch) through the panel and into the threaded holes in the chassis.
- 2 Fasten the panel to the chassis by tightening the screws. *Be sure not to overtighten the screws.*

Backup Power Supply Pinouts

OS6800-BPS-225 225W Backup Power Supply Connector

Pin Number	
1	-50 VDC
2	Ground
3	Enable
4	RPS_ABNORMAL
5	NC

OS6800-BPS-225 225W Backup Power Supply Cable

Pin Number	Power Shelf Side	Pin Number	Switch Side
2	Ground	1	-48 RTN
		2	NC
3	Enable	3	Enable
2	Ground	4	-48 RTN
		5	SYSPWRFAIL_L
1	-50 VDC	6	-48 DC
4	RPS_ABNORMAL	7	RPS_ABNORMAL
1	Ground	8	-48 DC
2	Enable	9	-48 RTN
	RPS_ABNORMAL	10	NC
2	NC	11	-48 RTN
	-50 VDC	12	Ground (Secondary)
	Ground	13	NC
1	Enable	14	-48 VDC
	RPS_ABNORMAL	15	NC
1	NC	16	-48 VDC

Viewing Primary and Backup Power Supply Status

The switch constantly monitors primary and backup power supply operation. If either the primary or backup power source unexpectedly shuts down, the switch sends out a notification to the user. In addition, the power LED on the chassis front panel and the LED on the backup power supply front panel (if installed) display solid amber.

Note. For detailed OS6800-24 and OS6800-48 LED information, refer to [“Status LEDs” on page 2-13](#).

To check the number of power supplies currently operating, and the status of each power supply, use the **show power** command. For example:

```
-> show power

Power Supplies in chassis 1
PS          Operational Status
-----+-----
PS-1 48V   UP
PS-2 48V   NOT PRESENT
```

The primary (i.e., factory-installed) power supply is listed as **PS-1** in the **show power** command output. The backup power supply is listed as **PS-2**. In the example above, there is no backup power supply installed.

Note. For information on viewing primary and backup power supply status *in a stacked configuration*, refer to [page 2-53](#).

Viewing Power Supply Status for Stacked Configurations

When entering the **show power** command on the primary switch in a stacked configuration, you can either enter only the **show power** syntax *or* you can specify a specific slot number. For more information, refer to the examples below.

A Slot Number is Specified

If you specify a *slot number* after the command syntax, power supply information for only the corresponding switch displays. For example:

```
Power Supplies in chassis 2
PS          Operational Status
-----+-----
PS-1 48V   UP
PS-2 48V   NOT PRESENT
```

In the example above, power supply status for the switch operating in slot 2 displays. No backup power supply is installed—or the backup power supply is powered off.

No Slot Number is Specified

If you do not enter a slot number, power supply information for *all switches in the stack* displays. For example:

```
-> show power

Power Supplies in chassis 1
PS      Operational Status
-----+-----
PS-1 48V  UP
PS-2 48V  UP

Power Supplies in chassis 2
PS      Operational Status
-----+-----
PS-1 48V  UP
PS-2 48V  NOT PRESENT

Power Supplies in chassis 3
PS      Operational Status
-----+-----
PS-1 48V  UP
PS-2 48V  UP
```

The example above shows the power supply status for a stack consisting of three switches. A backup power supply is present and running in switches operating in slots 1 and 3; no backup power supply is installed in the switch operating in slot 2—or the unit is powered off.

More Information on Stacked Configurations. For detailed information on stacked OmniSwitch 6800 Series switches, refer to [“Managing OmniSwitch 6800 Series Stacks” on page 3-1](#).

3 Managing OmniSwitch 6800 Series Stacks

In addition to working as individual stand-alone switches, OmniSwitch 6800 Series switches can also be linked together to work as a single virtual chassis known as a *stack*. With stacks, users can easily expand their switching capacity simply by adding additional switches to the stack. In addition, stacks provide enhanced resiliency and redundancy features. For more information, refer to [page 3-2](#).

Note. See [Chapter 2, “OmniSwitch 6800 Series Chassis and Hardware Components,”](#) for information on managing OmniSwitch 6800 Series switches in a stand-alone configuration.

In This Chapter

The chapter provides information on OmniSwitch 6800 Series switches configured to operate as a single virtual chassis. Topics described in this chapter include:

- OmniSwitch 6800 Series stack overview on [page 3-2](#).
- Roles within the stack on [page 3-2](#).
- Stack cabling on [page 3-15](#).
- Slot numbering on [page 3-18](#).
- Hot-Swapping modules in a stack on [page 3-22](#).
- Understanding tokens on [page 3-24](#).
- Reloading switches on [page 3-25](#).
- Changing the secondary module to primary on [page 3-33](#).
- Synchronizing switches in a stack on [page 3-35](#).
- Monitoring the stack on [page 3-36](#).

Note. You can also manage and monitor OmniSwitch 6800 Series stacks with WebView, Alcatel-Lucent’s embedded web-based device management application. WebView is an interactive and easy-to-use GUI that can be launched from OmniVista or a web browser. Please refer to WebView’s online documentation for more information.

OmniSwitch 6800 Series Stack Overview

Users can configure up to eight OmniSwitch 6800 Series switches—in any combination of OS6800-24 and OS6800-48 chassis types—into a single virtual chassis known as a *stack*. With stacks, switching capacity can be easily expanded simply by adding additional switches to the stack. For example, a user can start with a stack composed of two switches and add up to six additional switches to that stack as network demands increase over time.

Stacks also provide enhanced resiliency and redundancy features. If a switch in a stack goes down or is taken offline, the other elements in the stack will continue to operate without disruption. In addition, when a switch auto-synchronizes at boot-up—or if the user manually synchronizes the switches (see [“Synchronizing Switches in a Stack” on page 3-35](#) for more information)—operating software and configuration parameters are backed up on all switches in the stack. As a result, the original operating software and configuration parameters can be easily recovered if corrupted or otherwise lost.

Note on Terminology. In the user guides provided with your OmniSwitch 6800 Series switch, the terms *stack* and *virtual chassis* are interchangeable terms referring to OmniSwitch 6800 Series switches in a stacked configuration. The terms *module*, *switch*, *slot* and *element* are used to refer to individual switches within a stacked configuration. The terms *Chassis Management Module (CMM)* and *management module* refer to those switches operating in a stack either in primary or secondary management roles. OmniSwitch 6800 Series switches operating in an idle role are essentially acting as network interface modules and therefore may be referred to as *Network Interfaces (NIs)*.

Roles Within the Stack

In order to operate as a virtual chassis, switches within an OmniSwitch 6800 Series stack are assigned specific roles. These roles include primary and secondary management roles, idle status, and pass-through. For detailed descriptions of each of these roles, including their practical functions within the virtual chassis, refer to the sections below.

Primary and Secondary Management Modules

When OmniSwitch 6800 Series switches operate in a stack, one switch in the stack always assumes the *primary management* role. This primary element is responsible for functions such as software and configuration management, web-based management (i.e., WebView), SNMP management, switch diagnostics, and software rollback.

One additional switch in the stack operates in a *secondary management* role. This switch serves as a backup, and is always ready to assume the primary management role in the stack if the switch with the primary role fails or is taken offline for any reason.

Because the secondary module quickly and automatically assumes management responsibilities, switches operating in idle mode elsewhere in the stack continue to pass traffic without disruption. This redundancy provides effective safeguards for mission-critical network traffic and is one of the stack's most important failover features. Diagrams showing the management module failover sequence for stacks of three or more switches and stacks of two switches are provided on pages [3-3](#) and [3-4](#), respectively.

Important Note. For management module redundancy to work effectively, the software on all switches operating in the stack must be synchronized at all times. Refer to [“Synchronizing Switches in a Stack” on page 3-35](#) for more information.

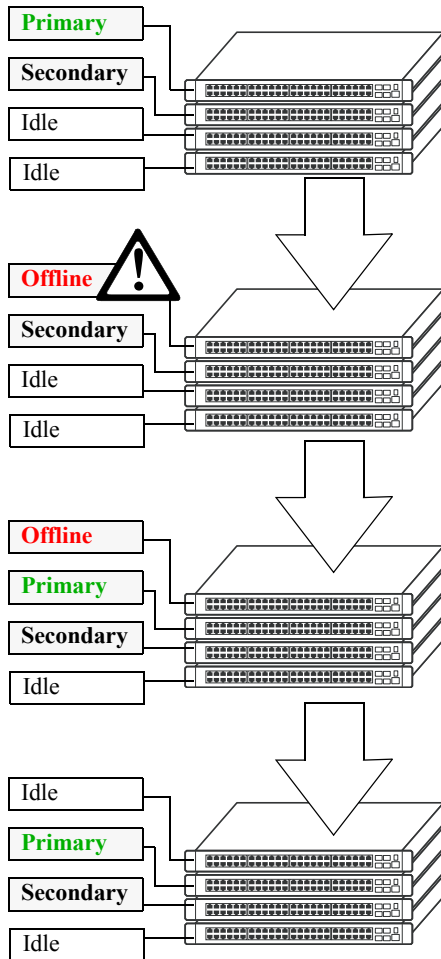

- 1 A stack of four OmniSwitch 6800 Series switches is operating normally. The stack consists of a primary module, secondary module, and two elements operating in idle status. (The software on all elements in the stack is synchronized.)
- 2 The primary management module in the stack fails or is taken offline (e.g., powered off or rebooted by the user).
- 3 The switch operating as the secondary management module immediately takes over the primary role. Meanwhile, the adjacent switch—previously operating in idle status—now assumes the secondary management role.
- 4 If the switch that failed or was taken offline comes back online, it will assume an idle role in the stack. In other words, it will act essentially as an NI module in the virtual chassis, passing traffic via its Ethernet ports.

Redundant Management Module Failover (Three or More Switches)

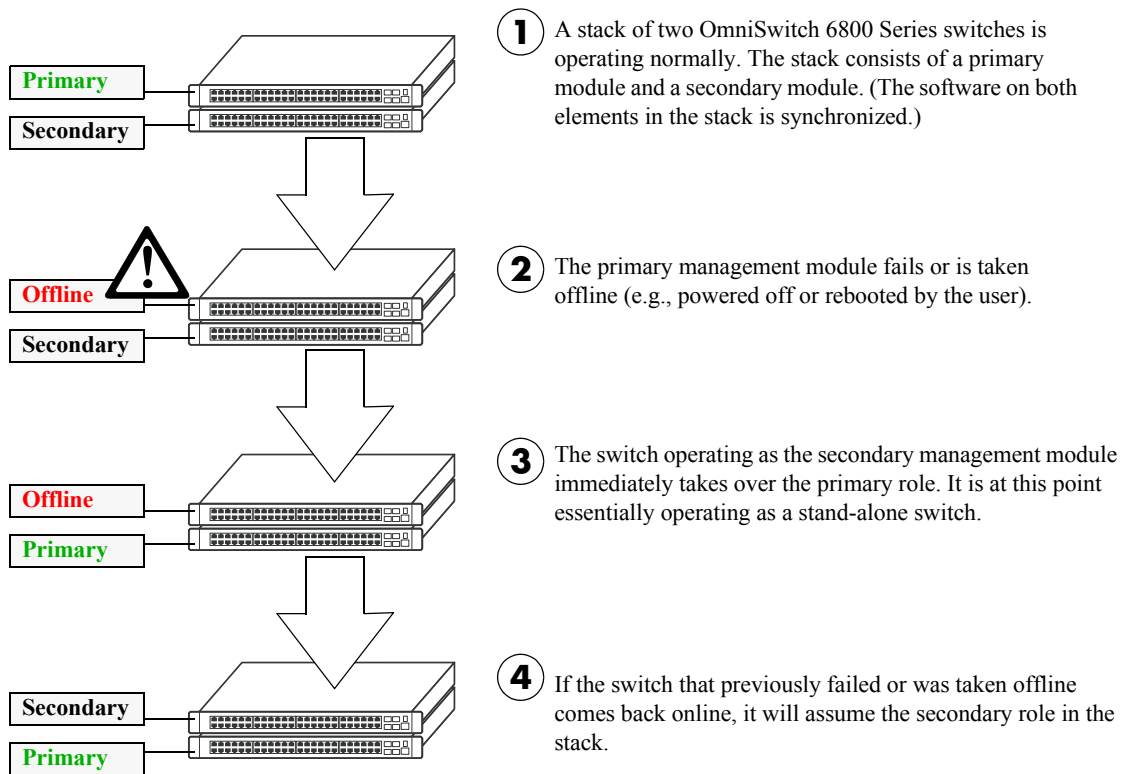

Redundant Management Module Failover (Two Switches)

Primary Management Module Selection

In order for a stack of OmniSwitch 6800 Series switches to operate as a virtual chassis, there must be mechanism for dynamically selecting which switch within the stack will assume the primary management role. OmniSwitch 6800 Series switches use three different methods for selecting the primary switch. These methods are:

- Chassis MAC address
- Saved slot number
- Chassis uptime

Note. Information on *secondary management module* selection is provided on [page 3-8](#). Information on dynamic assignment of *idle module* roles is provided on [page 3-10](#).

Using the Chassis MAC Address

By default, the primary management role will be given to the switch with the lowest chassis MAC address. However, for this to occur, all switches in the stack *must be booted within 15 seconds of each other*. In addition, switches in the stack *must have no preconfigured slot information*. Because of these two conditions, the MAC address method for selecting the primary module usually occurs with new “out of the box” switches, or switches from which any preconfigured slot information has been cleared.

For more information on using the lowest MAC address to determine the primary switch in a stack, refer to the diagram below:

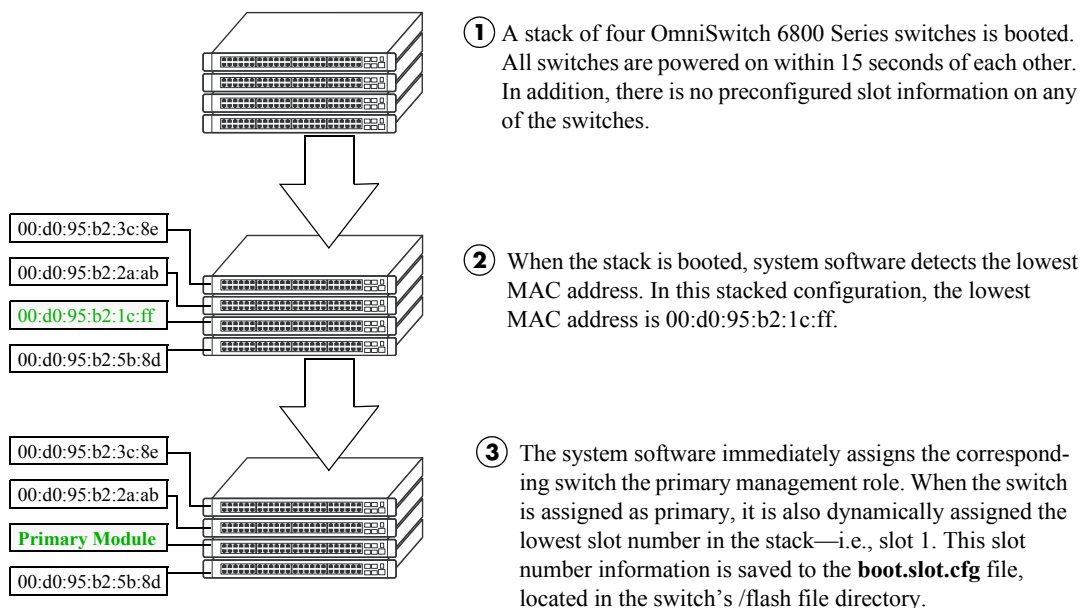

Primary Management Module Selection Using the Lowest Chassis MAC Address

Note. During the boot process, all other switches in the stack are also dynamically assigned unique slot numbers. As with the primary switch, these slot numbers are saved to the `boot.slot.cfg` file, located in the `/flash` file directory of each switch. For more information on dynamic slot number assignment, refer to “Slot Numbering” on [page 3-18](#).

Using Saved Slot Information

The saved slot number is the slot number the switch will assume following a reboot. This information is stored in a switch's **boot.slot.cfg** file; the switch reads its slot number assignment from this file at bootup and assumes the specified slot number within the stack.

If switches in a stacked configuration have no preconfigured slot assignments, the slot number for each switch is dynamically assigned by the system software. Slot numbers can also be manually assigned by the user. For more information on manually assigning slot numbers, refer to [“Manual Slot Number Assignment” on page 3-20](#).

When a stack with preconfigured slot information is booted, it is *not* the lowest MAC address that determines the primary management module. Instead, the slot information stored in each switch's **boot.slot.cfg** is read by the system software and used in determining the primary. The switch with the lowest saved slot number becomes the primary management module.

Note. Although, for ease-of-management purposes, it is recommended that slot numbers are assigned beginning with slot number 1, it is not a requirement. In other words, a stack of four switches can have slot assignments 3, 4, 5, and 6. However, it is important that each element in a stack is assigned a *unique* slot number. Do not assign duplicate slot numbers to elements in a stack. Otherwise, one or more switches will be forced into pass-through mode. For more information on pass-through mode, refer to [page 3-11](#).

For more information on using saved slot information to determine the primary switch in a stack, refer to the diagram below:

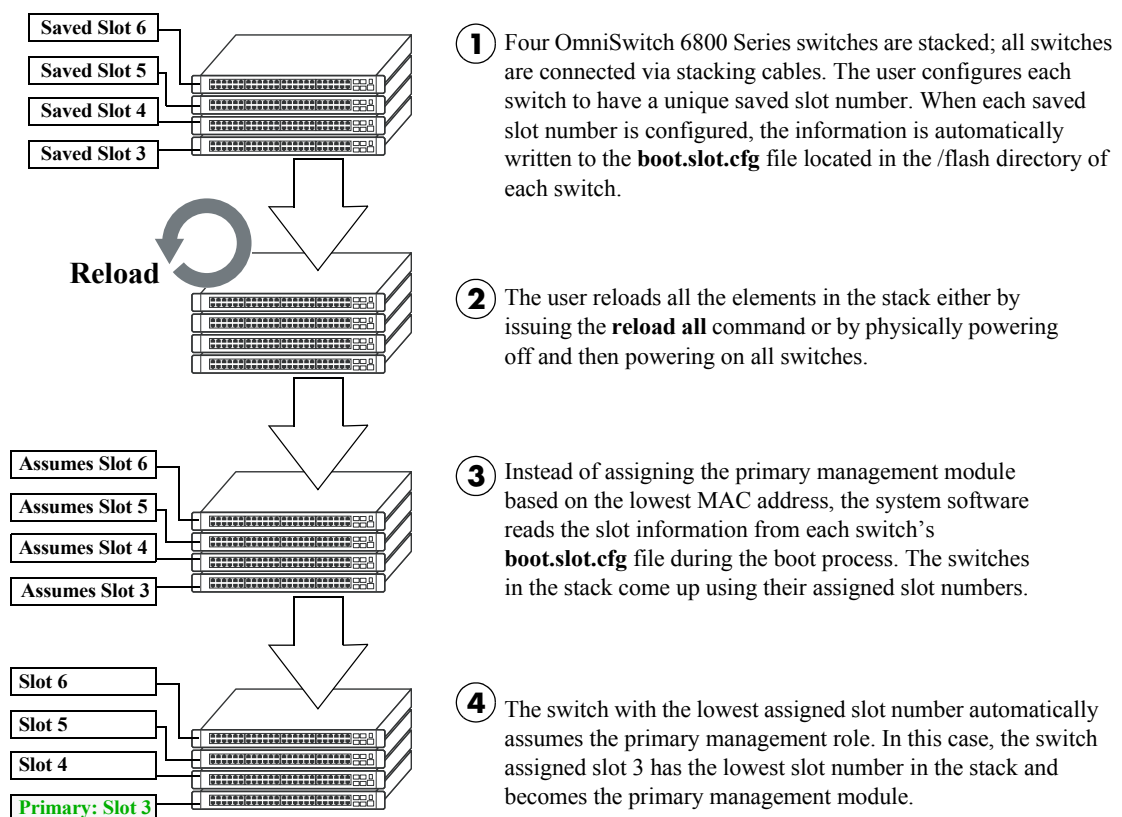

Primary Management Module Selection Using Saved Slot Information

Using Switch Uptime

A user can override both the MAC address and saved slot methods for determining a stack's primary management module. This is done by controlling the uptime of switches in the stack. If all elements of a stack are powered off, the user can force a particular switch to become primary by powering on that switch and waiting a minimum of 15 seconds before powering on any other switches. This can be useful if the user wants a switch placed in a specific location—e.g., the top-most switch in a stack—to become the primary.

As with the lowest MAC address method, the primary management module is dynamically assigned slot number 1 when the stack is booted.

For more information on using saved slot information to determine the primary switch in a stack, refer to the diagram below:

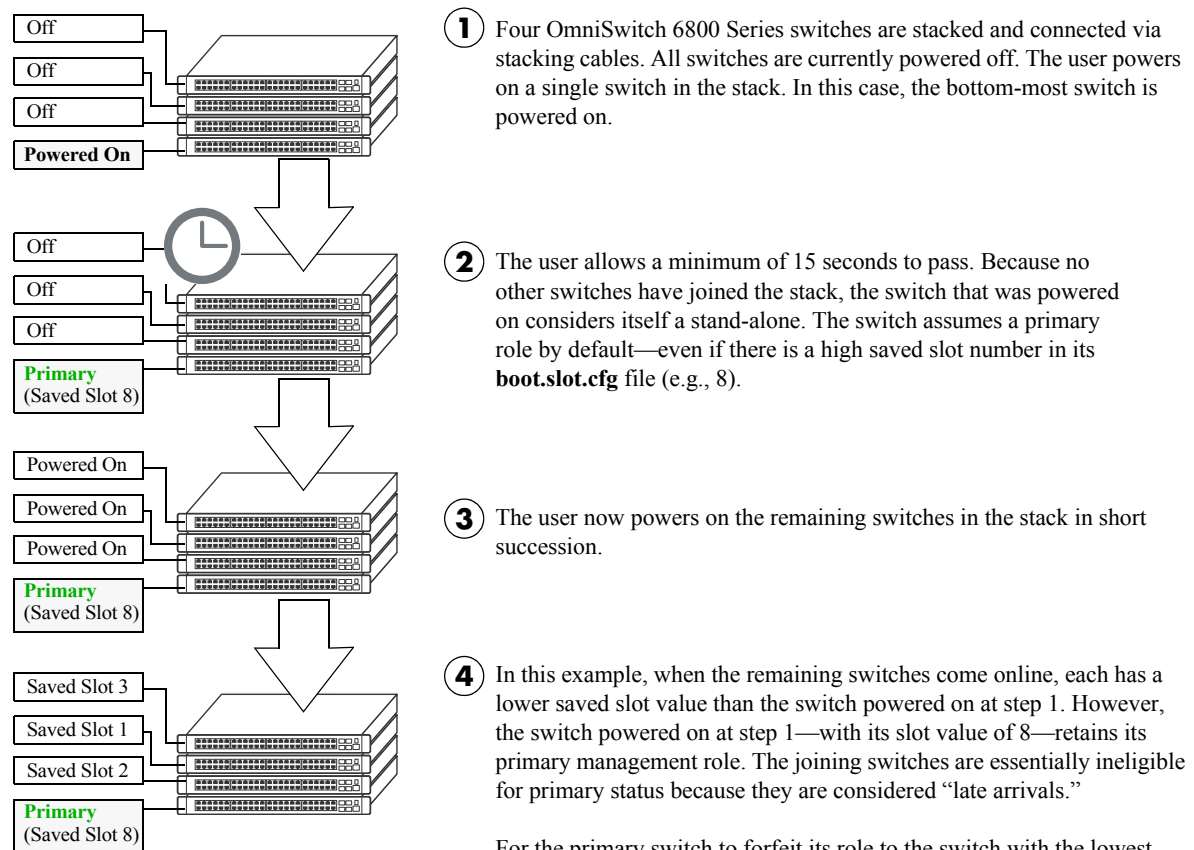

For the primary switch to forfeit its role to the switch with the lowest assigned slot number (in this case, slot number 1), the stack must be rebooted by the user either by issuing the `reload all` command or by powering off and powering on all switches in close succession.

Primary Management Module Selection Using Switch Uptime

Secondary Management Module Selection

In order to provide effective management module redundancy, all OmniSwitch 6800 Series stacked configurations dynamically assign a backup—or secondary—management module during the boot process. OmniSwitch 6800 Series stacks use two different methods for selecting the secondary switch. These methods are:

- Stacking connection to the primary switch
- Saved slot number

Using the Stacking Connection to the Primary Switch

By default, the switch that is connected to the primary switch's stacking port A is automatically assigned the secondary management role. This applies to stacks on which there is no preassigned slot information—i.e., there is no `boot.slot.cfg` file present in any switch.

For more information on using the stacking connection to the primary switch to determine the secondary management module, refer to the diagram below:

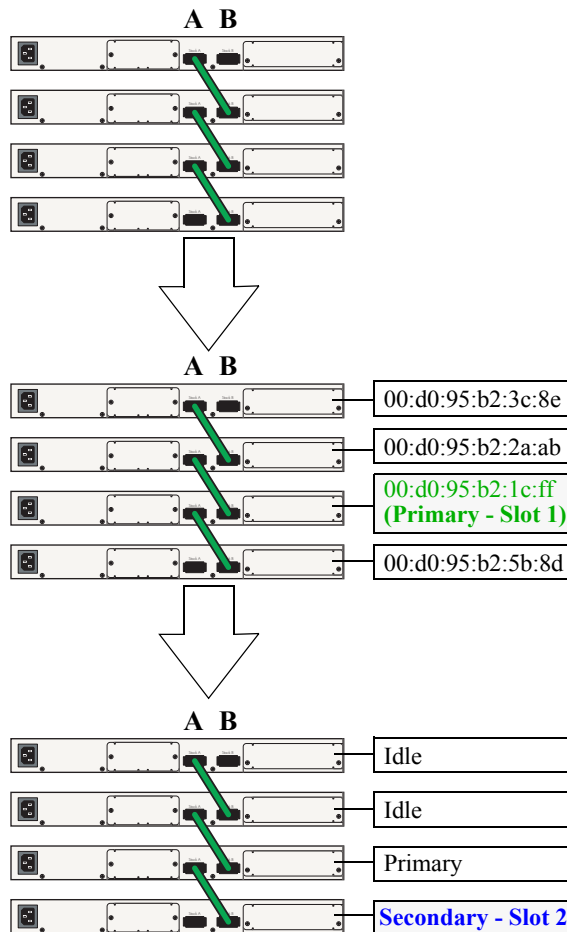

① Four OmniSwitch 6800 Series switches are stacked and connected via stacking cables, as shown. All switches are currently powered off. None of the switches have preassigned slot numbers—i.e., there are no `boot.slot.cfg` files present. The user powers on all switches in the stack in close succession and the stack begins the boot process.

② When the elements in the stack come online, the switch with the lowest MAC address is given the primary management role and is dynamically assigned slot number 1.

③ By default, the switch connected to the primary's stacking port A is automatically assigned the secondary management role. The secondary switch is dynamically assigned slot number 2.

Secondary Management Module Selection Using the Stacking Connection to the Primary Switch

Note. For information on dynamic slot numbering for idle elements within the stack, refer to [“Idle Module Role” on page 3-10](#) and [“Slot Numbering” on page 3-18](#).

Using Saved Slot Information

If a stack with preassigned slot information for each switch is booted, the switch with the *second-lowest* slot value is assigned the secondary management role. For example, if a stack of four switches is booted and the preassigned slot values for each switch are 1, 2, 3, and 4, the switch with the slot value of 2 is assigned the secondary role. Meanwhile, the switch with the slot value of 1 is assigned the primary management role (see [page 3-6](#)).

For more information on using saved slot information to determine the secondary management module in a stack, refer to the diagram below:

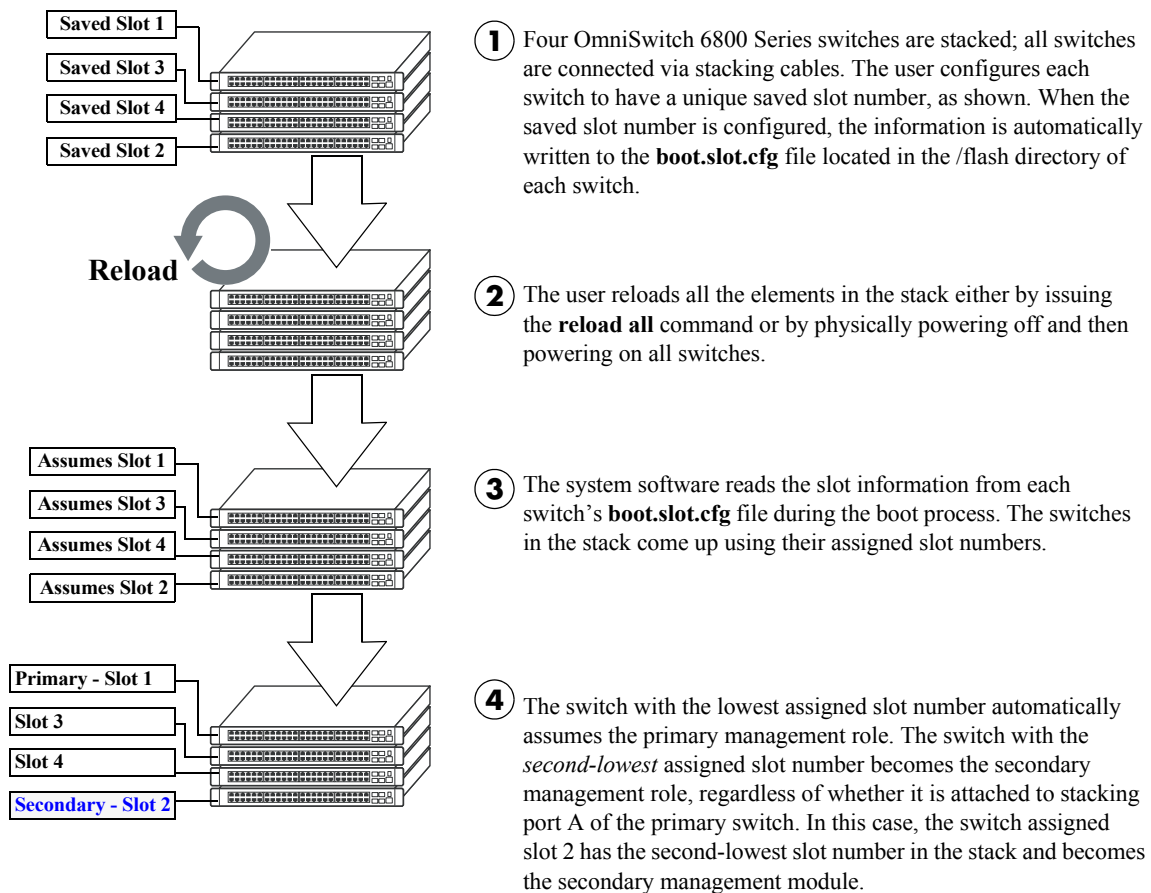

Secondary Management Module Selection Using Saved Slot Information

Reminder. Each element in a stack should always be assigned a *unique* slot number. Do not assign duplicate slot numbers to elements in a stack. Otherwise, one or more switches will be forced into pass-through mode. For more information on pass-through mode, refer to [page 3-11](#).

Idle Module Role

Switches that are not assigned either the primary or secondary role in a stack are, by default, assigned the role of *idle* modules. These idle modules operate similarly to Network Interface (NI) modules in a chassis-based switch, such as the OmniSwitch 9700/9800. It is the job of idle modules to send and receive 10/100/1000 Ethernet traffic on their ports.

In the event of a management module failure within the stack, the idle module with the next-lowest slot number in the stack will automatically assume the secondary management role. In other words, if the primary module in a stack goes down for any reason and the secondary takes over the primary management role, the switch must now assign a new secondary module. The idle element with the next-lowest slot number assumes this new responsibility until the situation is corrected and all elements in the stack are reloaded.

Note. Primary and secondary management modules also send and receive 10/100/1000 traffic on their Ethernet ports. The primary management module is like an NI module with the added task of overall stack management; the secondary management module is like an NI with the added responsibility of backing up the primary module in the event of a primary module failure. In other words, *all modules* in the virtual chassis can send and receive user data, regardless of their roles.

For more information on dynamic assignment of idle modules in a stack, refer to the diagram below:

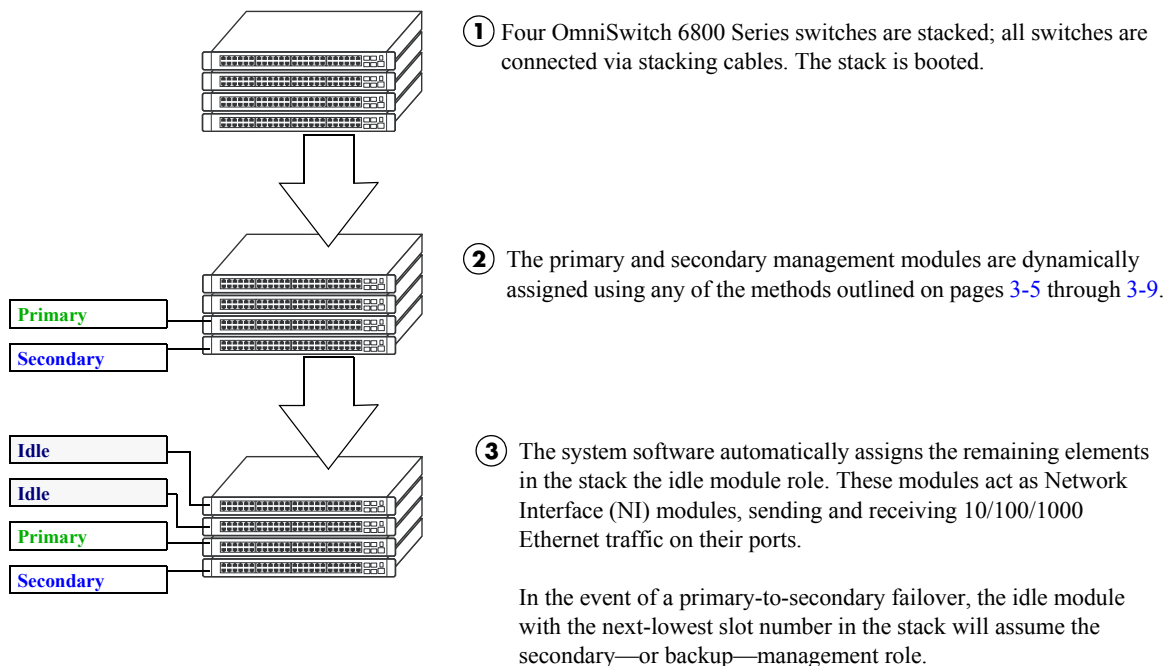

Secondary Management Module Selection Using Saved Slot Information

Pass-Through Mode

Pass-through mode is a state in which a switch has attempted to join a stack but has been denied primary, secondary, and idle status. When a switch is in pass-through mode, its Ethernet ports are brought down (i.e, they cannot pass traffic). Its stacking cable connections remain fully functional and can pass traffic through to other switches in the stack. In this way, pass-through mode provides a mechanism to prevent the stack ring from being broken. However, note that when a switch comes up in pass-through mode, it should not be left unresolved. Pass-through mode is essentially an error state that should be corrected immediately by the user.

Note. When a switch is in pass-through mode, its information will not display in hardware monitoring commands such as **show chassis**, **show ni**, **show module**, etc.

Conditions that can trigger a switch to enter pass-through mode include:

- Duplicate slot numbers have been assigned within the stack
- There are not adequate tokens available for the switch to join the stack (see [page 3-24](#))
- The user has manually forced the switch into pass-through mode using the **stack clear slot** command

Note. If a switch is forced into pass-through mode, the rest of the stack will not be disrupted. Any elements in the stack *not* operating in pass-through mode continue to operate normally.

The most common reason for one or more switches to enter pass-through is duplicate slot number assignments within the stack. So, in order to avoid pass-through mode, it is useful to keep track of the current saved slot numbers on all elements in the stack. Slot number assignments are stored in the **boot.slot.cfg** file in the /flash directory of each switch.

If the stack is booted and the same slot number is discovered on two or more switches, the switch with the lowest MAC address is allowed to come up and operate normally. Meanwhile, switches with the duplicate slot number *and* a higher MAC address come up in pass-through mode. To check the current slot number stored in each switch's **boot.slot.cfg** file, use the **show stack topology** command. For example:

```
-> show stack topology
```

NI	Role	State	Saved Slot	Link A State	Link A Remote NI	Link A Remote Port	Link B State	Link B Remote NI	Link B Remote Port
1	PRIMARY	RUNNING	1	UP	3	StackA	UP	2	StackA
2	SECONDARY	RUNNING	2	UP	1	StackB	UP	3	StackB
3	IDLE	RUNNING	2	UP	1	StackA	UP	2	StackB

In this example, note that both slots 2 and 3 have a saved slot value of 2. If this stack is rebooted, a duplicate slot error will occur and the switch with the lower MAC address will be given the secondary management role. The slot with the higher MAC address will be forced into pass-through mode.

To avoid a pass-through condition following a reboot, make sure that all saved slot values for the stack are unique. Use the **stack set slot** command. For example, change the saved slot value for the idle switch in slot 3 from 2 to 3:

```
-> stack set slot 3 saved-slot 2
```

Use the **show stack topology** command to verify the change:

```
-> show stack topology
```

NI	Role	State	Saved Slot	Link A State	Link A Remote NI	Link A Remote Port	Link B State	Link B Remote NI	Link B Remote Port
1	PRIMARY	RUNNING	1	UP	3	StackA	UP	2	StackA
2	SECONDARY	RUNNING	2	UP	1	StackB	UP	3	StackB
3	IDLE	RUNNING	3	UP	1	StackA	UP	2	StackB

Recovering from Pass-Through Mode (Duplicate Slot Numbers)

The first step in recovering from pass-through is to determine which modules are currently operating in pass-through, as well as the reason for the pass-through state. To view this information, use the **show stack topology** command. For example:

```
-> show stack topology
```

NI	Role	State	Saved Slot	Link A State	Link A Remote NI	Link A Remote Port	Link B State	Link B Remote NI	Link B Remote Port
1	PRIMARY	RUNNING	1	UP	1001	StackA	UP	2	StackA
2	SECONDARY	RUNNING	2	UP	1	StackB	UP	1001	StackB
1001	PASS-THRU	DUP-SLOT	2	UP	1	StackA	UP	2	StackB

Switches operating in pass-through mode are given distinct slot numbers. These slot numbers are not related to their position in the stack. Instead, they are assigned the prefix “100,” followed by the numerical order in which they were forced into pass-through (1001–1008).

Note. For pass-through elements 1001 through 1008, the slot indicator LED on the chassis front panel blinks 1 through 8, respectively. For example, if a module enters pass-through and has the slot number 1004, the LED for the module blinks the number 4. For more information on the slot indicator LED, refer to “[Status LEDs](#)” on page 2-13.

In the example above, the switch with the NI (i.e., slot) number 1001 is operating in pass-through. Note that the role assignment is PASS-THRU; also, the state displays DUP-SLOT, or *duplicate slot number*. This can be further verified by looking down the saved slot column in the table. Note that slot 2, operating in the secondary management role, has a saved slot value of 2. Slot 1001, operating in pass-through, also has a saved slot value of 2.

To resolve this pass-through condition, simply assign slot 1001 a new saved slot value and reboot the module. This can be done in either of two ways:

- Use the **stack set slot** command to assign the new value, then use the **reload pass-through** command to reboot the module:

```
-> stack set slot 1001 saved-slot 3
-> reload pass-through 1001
```

- Use the **stack set slot** command to assign the new slot value and, using the optional **reload** syntax in the command line, reboot the module:

```
-> stack set slot 1001 saved-slot 3 reload
```

When the module comes up, it assumes the new, unique slot position—in this case, slot 3—and, because it now has the highest slot number in the stack, it assumes an idle role (leaving the primary and secondary roles to slots 1 and 2, respectively). There are now no duplicate numbers in the stack and all elements are operating normally:

```
-> show stack topology
```

NI	Role	State	Saved Slot	Link A State	Link A Remote NI	Link A Remote Port	Link B State	Link B Remote NI	Link B Remote Port
1	PRIMARY	RUNNING	1	UP	3	StackA	UP	2	StackA
2	SECONDARY	RUNNING	2	UP	1	StackB	UP	3	StackB
3	IDLE	RUNNING	3	UP	1	StackA	UP	2	StackB

In some pass-through conditions (for example, larger stacks where multiple switches are in pass-through mode), it might be desirable to correct any duplicate saved slot assignments and then reboot the entire stack. The recovery from pass-through can be accomplished with fewer steps than reassigning slot numbers and rebooting modules on a slot-by-slot basis. However, be sure that there is no mission-critical traffic being passed on the non-pass-through modules; traffic will be interrupted on these modules during the reboot.

The following example shows a large stack with multiple elements operating in pass-through mode:

```
-> show stack topology
```

NI	Role	State	Saved Slot	Link A State	Link A Remote NI	Link A Remote Port	Link B State	Link B Remote NI	Link B Remote Port
4	IDLE	RUNNING	4	UP	5	StackB	UP	3	StackA
5	IDLE	RUNNING	5	UP	1001	StackB	UP	4	StackA
1001	PASS-THRU	DUP-SLOT	2	UP	2	StackB	UP	5	StackA
2	SECONDARY	RUNNING	2	UP	1003	StackB	UP	1001	StackA
1003	PASS-THRU	DUP-SLOT	2	UP	1002	StackB	UP	2	StackA
1002	PASS-THRU	DUP-SLOT	2	UP	1	StackB	UP	1003	StackA
1	PRIMARY	RUNNING	1	UP	3	StackB	UP	1002	StackA
3	IDLE	RUNNING	3	UP	4	StackB	UP	1	StackA

This disordered stack topology, with its three modules operating in pass-through mode, can be corrected by entering the following commands:

```
-> stack set slot 4 saved-slot 1
-> stack set slot 5 saved-slot 2
-> stack set slot 1001 saved-slot 3
-> stack set slot 2 saved-slot 4
-> stack set slot 1003 saved-slot 5
-> stack set slot 1002 saved-slot 6
-> stack set slot 1 saved-slot 7
-> stack set slot 3 saved-slot 8
-> reload all
```

When all elements in the stack come up following the reboot, there are no longer any duplicate slot numbers in the stack. In addition, the stack topology is more orderly and, as a result, easier to manage:

```
-> show stack topology
```

NI	Role	State	Saved Slot	Link A State	Link A Remote NI	Link A Remote Port	Link B State	Link B Remote NI	Link B Remote Port
1	PRIMARY	RUNNING	1	UP	2	StackB	UP	8	StackA
2	SECONDARY	RUNNING	2	UP	3	StackB	UP	1	StackA
3	IDLE	RUNNING	3	UP	4	StackB	UP	2	StackA
4	IDLE	RUNNING	4	UP	5	StackB	UP	3	StackA
5	IDLE	RUNNING	5	UP	6	StackB	UP	4	StackA
6	IDLE	RUNNING	6	UP	7	StackB	UP	5	StackA
7	IDLE	RUNNING	7	UP	8	StackB	UP	6	StackA
8	IDLE	RUNNING	8	UP	1	StackB	UP	7	StackA

Stack Cabling

Switches are connected to each other in a stack with stacking cables. These stacking cables provide high-speed, dual-redundant links between switches in a stack.

Stacking cables for OmniSwitch 6800 Series switches can be connected in any pattern. In other words, the cable connected to stacking port A of one switch can be connected to either stacking port A or stacking port B of the adjacent switch. However, it is strongly recommended that the cabling pattern remains consistent across the stack. In addition, for a stack to have effective redundancy, *a redundant stacking cable must be installed between the upper-most and bottom-most switch at all times*. This provides effective failover in the event of a stacking link or module failure within the stack.

The diagram below shows two recommended stacking cable patterns. For detailed information on assembling a stack and connecting the cables, refer to [Chapter 2, “OmniSwitch 6800 Series Chassis and Hardware Components.”](#)

Note. When planning the stack cabling configuration, keep in mind that the switch connected to stacking port A of the primary switch will be assigned the secondary management role by default.

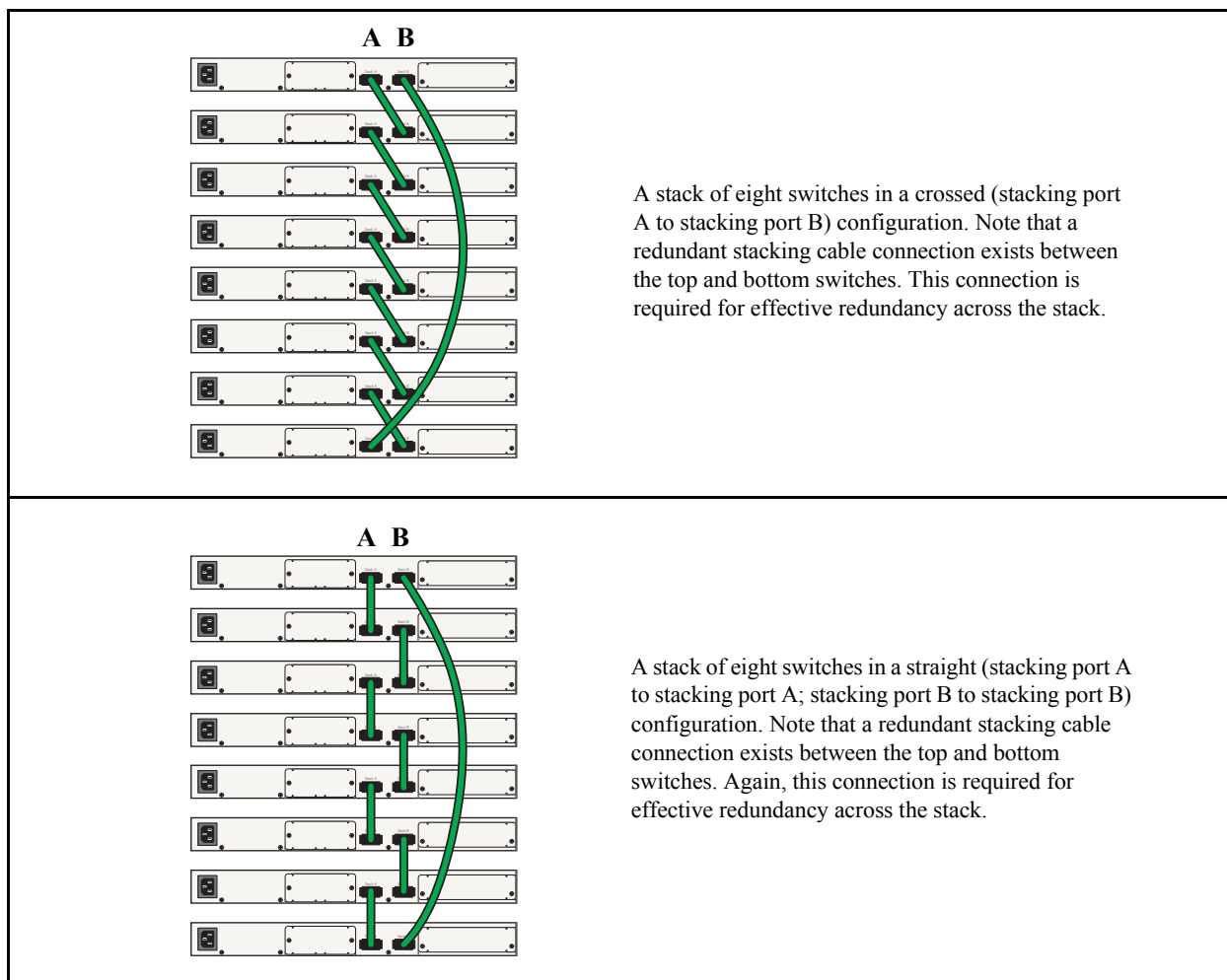

Examples of Stacking Cable Patterns (Chassis Rear Panels Shown)

Redundant Stacking Cable Connection

OmniSwitch 6800 Series switches allow redundant stacking cable connections between the top-most and bottom-most switches in a stack.

Important. For a stacked configuration to have effective redundancy, a redundant stacking cable must be installed between the upper-most and bottom-most switch in the chassis at all times.

The figure below shows how the redundant connection between the top and bottom switches in the stack ensures that data will continue to flow throughout the stack, even in the event of a connection failure at one of the stacking cables.

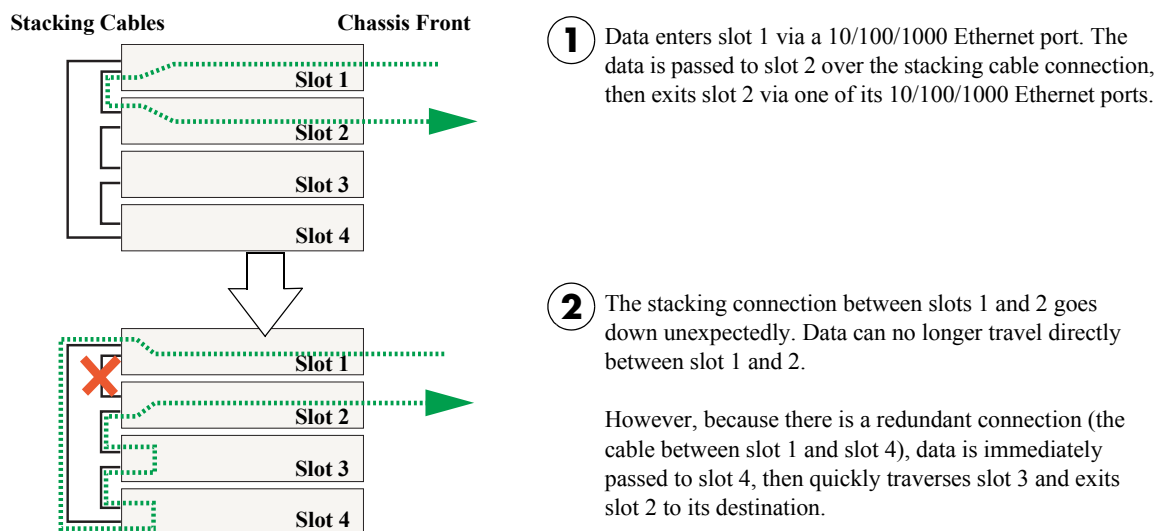

1 Data enters slot 1 via a 10/100/1000 Ethernet port. The data is passed to slot 2 over the stacking cable connection, then exits slot 2 via one of its 10/100/1000 Ethernet ports.

2 The stacking connection between slots 1 and 2 goes down unexpectedly. Data can no longer travel directly between slot 1 and 2.

However, because there is a redundant connection (the cable between slot 1 and slot 4), data is immediately passed to slot 4, then quickly traverses slot 3 and exits slot 2 to its destination.

Stacking Cable Redundancy: Recovery Following a Stacking Link Failure

Redundant stacking cables provide a form of *dual* redundancy. As shown in the figure above, the redundant cable allows traffic to flow in the event of a stacking link failure. The redundant cable also provides failover if a *switch* goes down within the stack. Traffic continues to flow between the modules that remain operational, as shown in the diagram below:

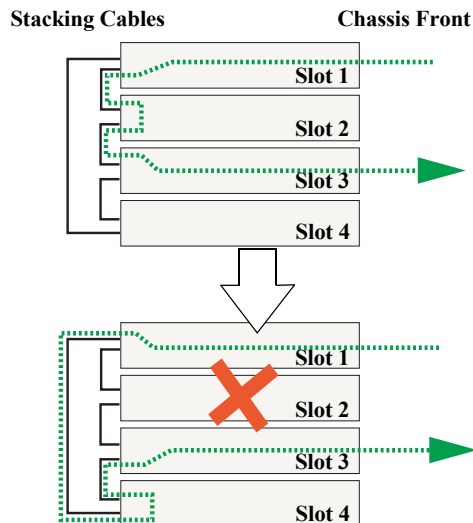

1 Data enters slot 1 through a 10/100/1000 Ethernet port. The data traverses slot 2 via the stacking cables and exits slot 3 through one of its 10/100/1000 Ethernet ports.

2 The slot 2 switch goes down unexpectedly. Data can no longer move through slot 2.

However, because there is a redundant connection (the cable between slot 1 and slot 4), data immediately traverses slot 4 and then exits slot 3 to its destination.

Stacking Cable Redundancy: Recovery Following a Switch Failure within the Stack

Checking Redundant Stacking Cable Status

To check whether a redundant stacking cable connection exists between the top-most and bottom-most switches in the stack, use the `show stack status` command. For example:

```
-> show stack status
Redundant cable status : present
Tokens used           : 12
Tokens available      : 20
```

In this example, a redundant stacking cable connection is present between the top-most and bottom-most switches in the stack.

Slot Numbering

For a stack of OmniSwitch 6800 Series switches to operate as a virtual chassis, each module in the stack must be assigned a unique slot number. To view the current slot assignments for a stack, use the **show ni** or **show module** commands. The slot number is also displayed on the front panel of each switch by the LED located on the right side of the chassis (refer to “Status LEDs” on page 2-13 for more information).

There are two ways stacking modules are assigned slot numbers:

- Dynamic slot number assignment by the system software
- Manual slot number assignment by the user

Dynamic Slot Number Assignment

Dynamic slot number assignment occurs when there are no **boot.slot.cfg** files present in the switches’ /flash directories. This is the case for new, “out of the box,” switches that have not been previously booted.

When a brand new stack (or stack with no **boot.slot.cfg** files) is booted, the system software automatically detects the module with the lowest MAC address. This module is assigned the primary management role (see page 3-2) and, by default, is given the slot number 1. The module connected to the primary’s stacking port A is automatically assigned the secondary management role and given the slot number 2.

As the other modules in the stack become operational, they are assigned idle roles and are automatically assigned unique slot numbers (3–8, depending on the number of switches in the stack). The slot numbering for idle modules is determined by each module’s physical location in the stack. Refer to the diagrams below for more information on dynamic slot numbering.

Note. As the slot numbers are dynamically assigned, **boot.slot.cfg** files are auto-generated in the /flash directory of each switch. When modules are subsequently booted, each switch reads its slot number assignment from this file and comes up accordingly.

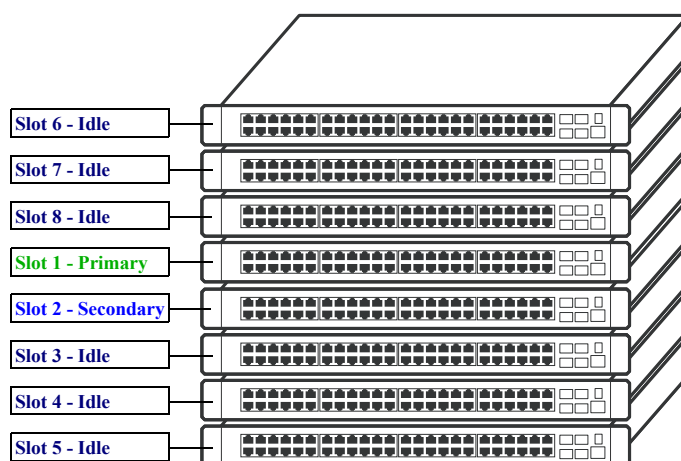

In this example, the fourth switch from the top is elected the primary management module for the stack. (It can be assumed that this switch has the lowest MAC address in the stack.) This switch is automatically assigned slot number 1.

The switch immediately below is connected to the primary switch’s stacking port A and, as a result, is assigned the secondary management role and given slot number 2.

The system software allows the switch immediately below slot 2 to have the next slot number preference. It is assigned an idle role and given the slot number 3. The switch immediately below slot 3 is given the slot number 4, and so on. When the bottom of the stack is reached, the slot numbering sequence resumes at the top of the stack, as shown. This helps ensure a more ordered and manageable stack topology.

Dynamic Slot Numbering Example 1

If the switch with the lowest MAC address happens to be the bottom-most module in the stack, slot numbering will not resume from the top of the stack. Instead, the system software will select the secondary module using the standard method (i.e., the switch connected to the primary's stacking port A), then continue to number the stack from the bottom up. This intuitive slot assignment provides the cleanest and most manageable stack topology. Refer to the diagram below for more information.

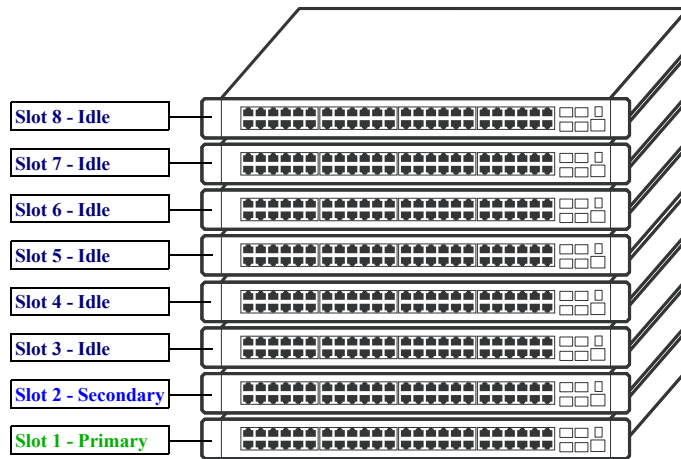

In this example, the bottom switch is elected the primary management module for the stack. (It can be assumed that this switch has the lowest MAC address in the stack.) This switch is automatically assigned slot number 1.

The switch immediately above is connected to the primary switch's stacking port A and, as a result, is assigned the secondary management role and given slot number 2.

The system software then sequentially assigns slot numbers up the stack. In other words, the switch immediately above slot 2 is assigned the slot number 3; the switch immediately above slot 3 is assigned the slot number 4, and so on. This default procedure ensures the most ordered and manageable stack topology out of the box.

Dynamic Slot Numbering Example 2

Manual Slot Number Assignment

To manually assign slot numbers to one or more modules in a stack, use the **stack set slot** command. This command writes slot information to the **boot.slot.cfg** file located in a switch's /flash directory. It is this *saved slot* information that the switch will assume following a reboot.

Manually assigning slot numbers can be useful in reordering existing slot numbers in order to create a sequential numbering scheme from the top of the stack to the bottom (or vice-versa). Refer to the following example:

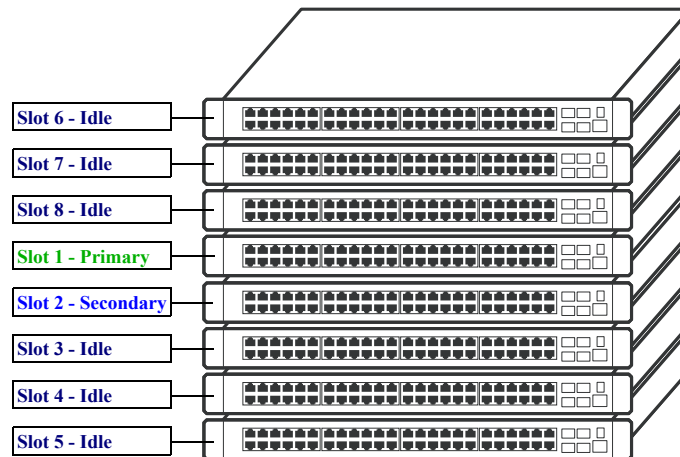

This example, taken from [page 3-18](#), shows a stack in which the primary and secondary switches are physically positioned in the middle of the stack. Although the stack will operate normally with this primary and secondary module positioning, it may be preferable for management purposes to have the primary and secondary switches at either the top or the bottom of the stack. For this example, the primary and secondary roles will be assigned to the top of the stack. This is accomplished by entering the following commands:

```
-> stack set slot 6 saved-slot 1
-> stack set slot 7 saved-slot 2
-> stack set slot 8 saved-slot 3
-> stack set slot 1 saved-slot 4
-> stack set slot 2 saved-slot 5
-> stack set slot 3 saved-slot 6
-> stack set slot 4 saved-slot 7
-> stack set slot 5 saved-slot 8
-> reload all
```

Because slot 6 is the top-most switch in the stack, it is reassigned the slot 1 (i.e., primary) position; because slot 7 is located immediately below slot 6, it is reassigned the slot 2 (i.e., secondary) position, etc.

Note that the modules were not reloaded one-by-one, even though the **stack set slot** command provides optional syntax for doing so. Instead, new slot number information is first saved to each **boot.slot.cfg** file across the stack. The reboot is saved for last in order to avoid duplicate slot numbers within the stack, which would cause unwanted pass-through mode conditions (see [page 3-11](#)).

When the stack comes up following the reboot, the manually-configured slot numbers display as follows:

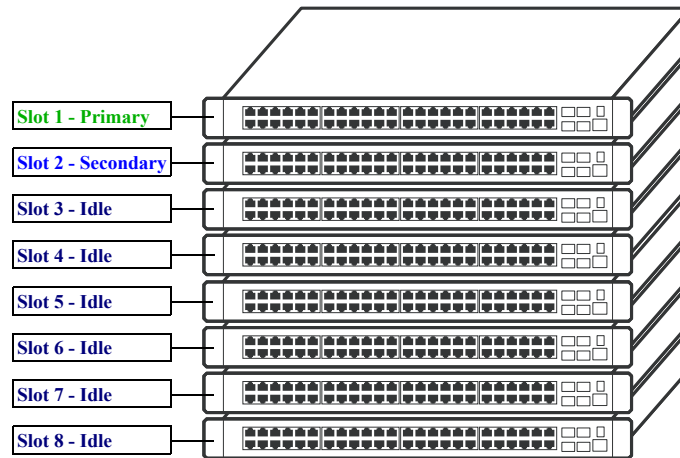

Note. The `stack set slot` command can also be used to manually correct duplicate saved slot assignments within the stack topology. Refer to pages [3-11](#) through [3-13](#) for detailed information.

Reverting to the Dynamic Slot Numbering Model

To clear the `boot.slot.cfg` files from the stack's `/flash` directories, use the `stack clear slot` command on all modules and then reboot the stack. For example:

```
-> stack clear slot 1
-> stack clear slot 2
-> stack clear slot 3
-> stack clear slot 4
-> stack clear slot 5
-> stack clear slot 6
-> stack clear slot 7
-> stack clear slot 8
-> reload all
```

The commands shown above clear the saved slot information from all modules in an eight-module stacked configuration and then reboot the stack. Because the system software no longer has preassigned slot information to read during the boot process, the stack uses the dynamic slot number assignment method described on [page 3-18](#).

Hot-Swapping Modules In a Stack

As with chassis-based switches such as the OmniSwitch 9700/9800, NI modules within an OmniSwitch 6800 Series virtual chassis are hot-swappable. NI modules are essentially those modules operating in the stack in idle mode. These modules can be removed from, or added to, an existing stack without disrupting other modules in the stack.

Removing Switches from an Existing Stack

When removing switches from an existing stack, observe the following important guidelines:

- Do not attempt to hot-swap modules operating in primary or secondary management roles
- Be sure the stacking cables and stacking cable redundancy are not disrupted

Hot-swapping is intended for switches in *idle* and, if applicable, *pass-through* status only. Removing primary or secondary management modules from a stack will trigger a failover sequence—i.e., one or more additional modules within the stack must reload in order to reassign the management roles. Whenever possible, avoid removing a switch that is operating as a primary or secondary management module.

Also, removing a switch from a stacked configuration can disrupt stack cabling at the rear of the stack. When removing a module, be sure that stacking link integrity—including important stacking cable redundancy—is maintained between all remaining modules. For more information on stacking cable connections, refer to [page 3-15](#).

Inserting Switches Into an Existing Stack

When inserting switches into an existing stack, observe the following important guidelines:

- Avoid duplicate saved slot numbers
- Never attempt to operate more than eight switches in a single stack
- Be sure that there are adequate tokens available to accommodate the incoming module(s)
- Make sure all switches are running the same software version

Note. Other stackable Alcatel-Lucent products, such as the OmniSwitch 6600 Series switch, *cannot* be added to an OmniSwitch 6800 Series virtual chassis.

To avoid duplicate slot numbers, simply make sure that any modules being added to an existing stack have been cleared of preassigned slot information. In other words, verify that there is no **boot.slot.cfg** file present in the /flash directory of any switch being added. When the switch is connected to the existing stack and booted, the system software automatically assigns it a unique slot number. No duplicate slot errors occur.

Note. If it is preferable to add a switch with an existing **boot.slot.cfg** file to a stack, be sure that the saved slot number of the incoming switch is not already assigned to a switch operating in the stack.

Merging Stacks

Merging stacks involves connecting two or more operational stacks and attempting to reboot them as a single virtual chassis. In most cases, errors will result. To merge stacks without causing errors, select one stack that is to remain up and running and then add modules from the other stack(s) by following the steps below:

- 1** Make sure all switches are running the same software version.
- 2** Clear the saved slot information from all incoming modules. This will ensure that they are each assigned unique slot numbers when they join the stack.
- 3** After clearing the saved slot information, power off all incoming modules.
- 4** Connect the stacking cables for all incoming modules to the existing, operational stack as required. Be sure to provide stacking cable redundancy. For information on stack cabling, refer to [page 3-15](#).
- 5** Power on all incoming modules.

Note. No more than eight switches can operate in a single stacked configuration at any time. In addition, a single stack provides 32 tokens for all hardware operating within the stack. If a module is inserted into an existing stack and not enough tokens are available, an error will result. Refer to [“Understanding Tokens” on page 3-24](#) for more information.

Understanding Tokens

OmniSwitch 6800 and OmniSwitch 6800L switches use global module identifiers—referred to as *tokens*—for budgeting stack ASIC resources. Each stack offers 32 tokens, with each module added to the stack using a specific number of these tokens. For a list showing the number of tokens used by each module type, refer to the table below.

Module Type	Tokens Used	Maximum Allowed per Stack
OS6800-24	2	8
OS6800-24L	2	8
OS6800-48	4	8
OS6800-48L	4	8
OS6800-48 with 10 Gigabit uplink	6	5
OS6800-48L with 10 Gigabit uplink	6	5
OS6800-U24	2	N/A
OS6800-U24 with 10 Gigabit uplink	4	N/A

Reminder. OS6800-U24 switches do not support stacking.

The maximum allowance of *eight modules per stack* takes precedence over the number of tokens used. In other words, although it takes 16 OS6800-24 switches to use up all 32 allotted tokens, no more than eight switches can be stacked together at any time.

If a switch attempts to join a stack and there are not adequate tokens available, the incoming switch is automatically placed in pass-through mode. For more information, refer to [“Pass-Through Mode” on page 3-11](#).

Checking Tokens Currently Used In a Stack

To check the number of tokens currently used in a stacked configuration, use the [show stack status](#) command. For example:

```
-> show stack status
Redundant cable status : present
Tokens used             : 12
Tokens available        : 20
```

In this example, the current stacked configuration is using 12 of the 32 available tokens; this leaves 20 tokens available for any modules brought into the stack.

Note. To view the types of modules (e.g., OS6800-24, OS6800-48, etc.) used in the current stacked configuration, use the [show module](#) command.

Reloading Switches

Reloading is essentially a soft boot of a switch. Users can reload stacked modules operating in any role—i.e., primary, secondary, idle, and pass-through. Refer to the sections below for more information.

Reloading the Primary Management Module

If the switch with the primary management role is reloaded, the switch with the secondary role automatically takes over primary management functions. In other words, the switch with the secondary role assumes the primary role as soon as the reload is initiated.

Meanwhile, the idle switch with the next-lowest slot number automatically assumes the secondary role. When the reloaded switch (the former primary module) comes back up, it assumes an idle role within the stack.

To reload the primary management module, use the **reload** command. The optional syntax **primary** can be used in the command line, but is not required. For example:

```
-> reload primary
```

Note. A primary management module reload can also be scheduled for a later time or date. For information on scheduling a primary module reload, as well as additional command details, refer to the *OmniSwitch CLI Reference Guide*.

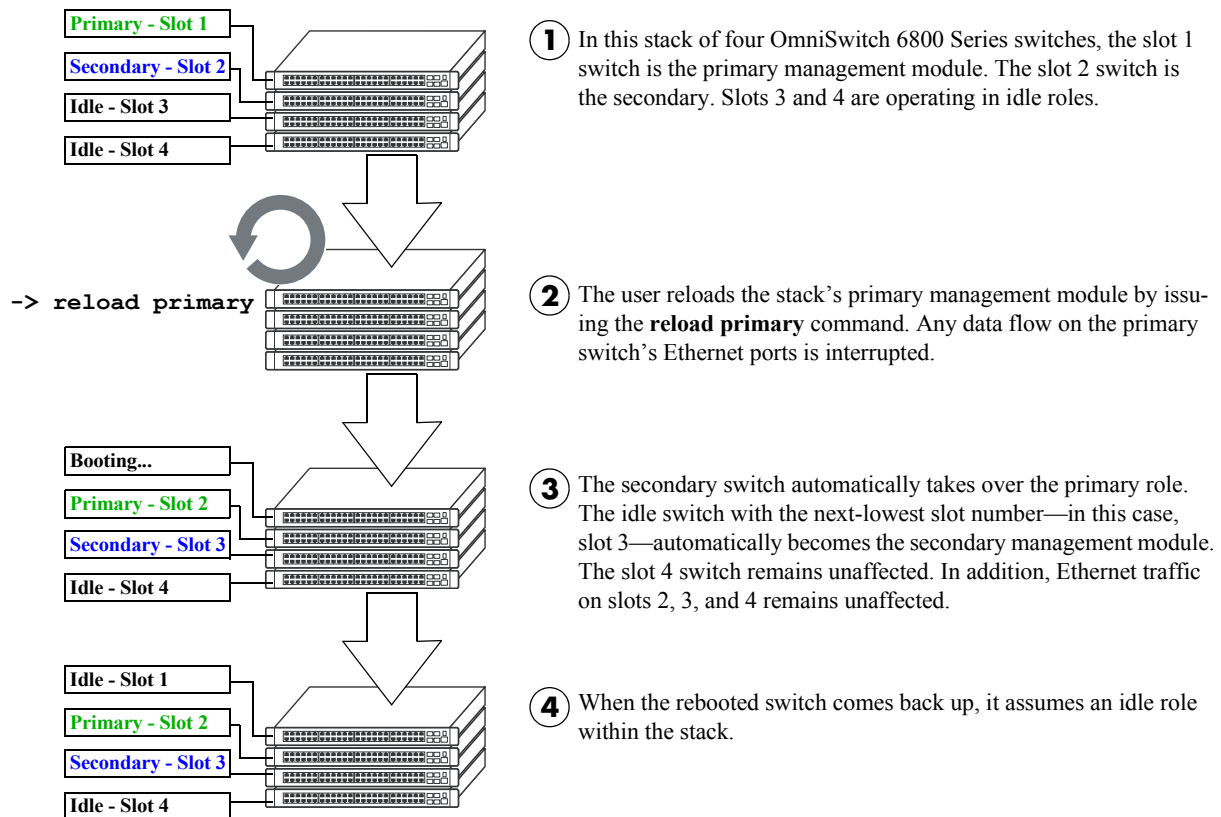

Reloading the Primary Management Module In a Stack of Three or More

If there are only two switches in the stack, the switch that was reloaded (the former primary) assumes the secondary role when it comes back up.

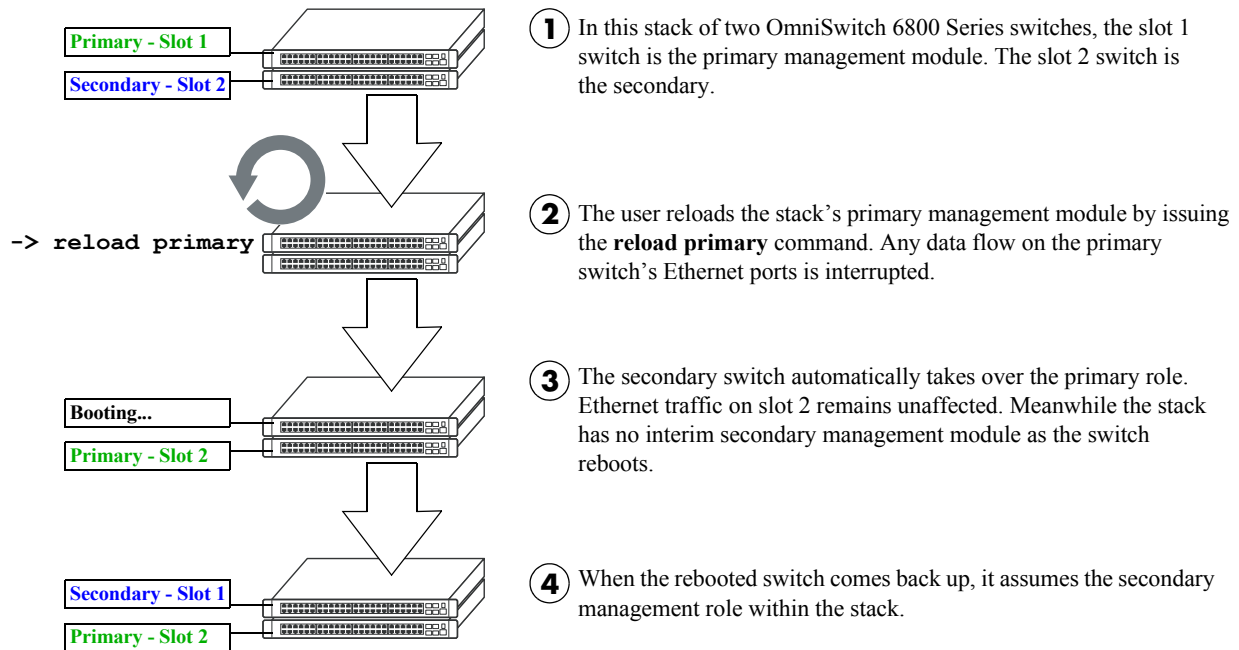

Reloading the Primary Management Module In a Stack of Two

Reloading the Secondary Management Module

If the switch with secondary management role is reloaded, the idle switch with the lowest slot number will automatically assume the secondary role. The reloaded switch (the former secondary) will assume an idle role when it comes back up.

Meanwhile, the switch with the primary management role, as well as any other idle modules in the stack, continue operations without interruption.

To reload the secondary management module, use the **reload** command. Be sure to include the syntax **secondary** in the command line. For example:

```
-> reload secondary
```

Note. A secondary management module reload can also be scheduled for a later time or date. For information on scheduling a secondary module reload, as well as additional command details, refer to the *OmniSwitch CLI Reference Guide*.

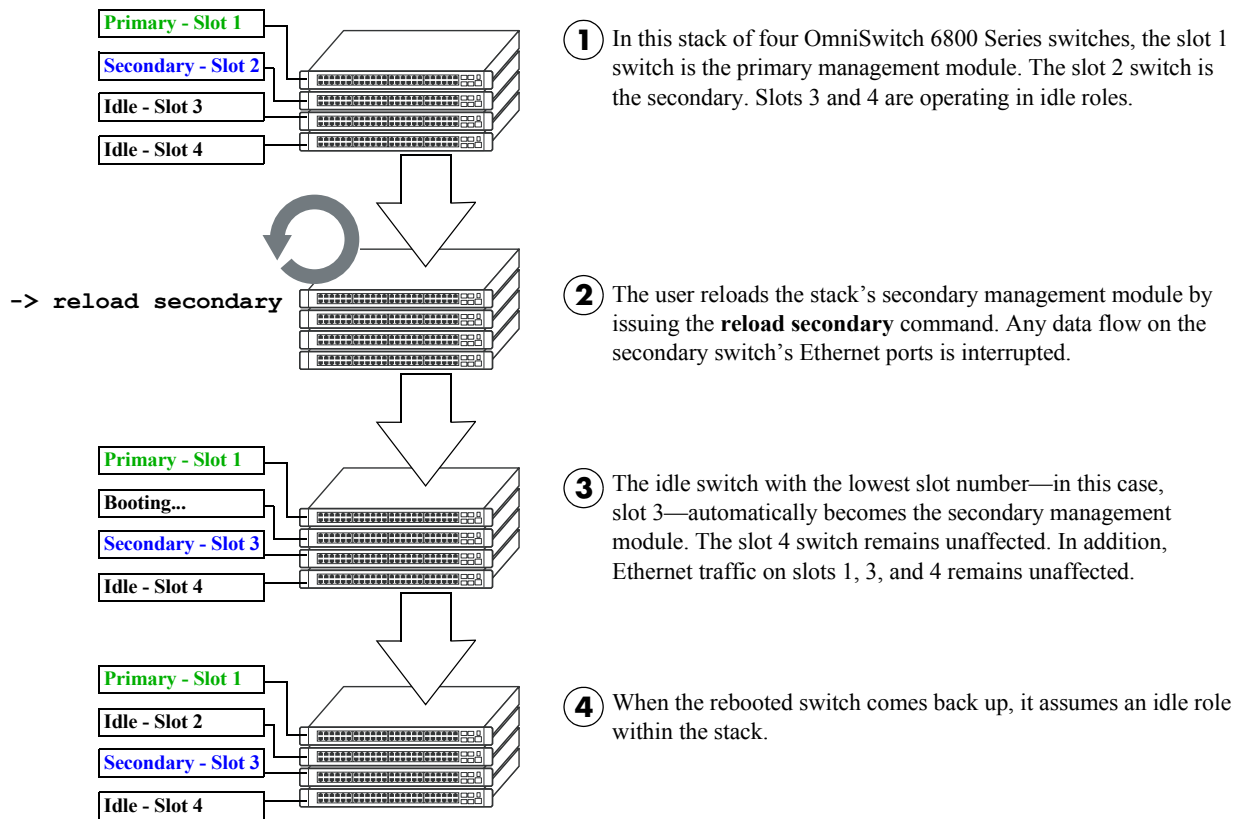

Reloading the Secondary Management Module In a Stack of Three or More

If there are only two switches in the stack, the switch that was reloaded (the former secondary) resumes the secondary role when it comes back up.

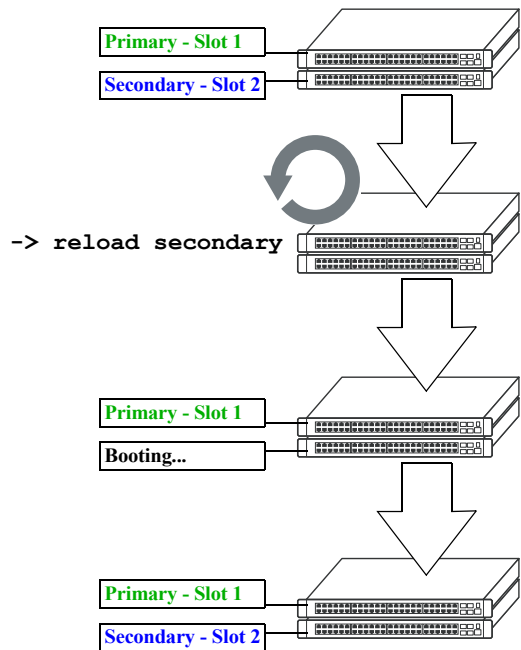

- ① In this stack of two OmniSwitch 6800 Series switches, the slot 1 switch is the primary management module. The slot 2 switch is the secondary.
- ② The user reloads the stack's secondary management module by issuing the **reload secondary** command. Any data flow on the secondary switch's Ethernet ports is interrupted.
- ③ As the secondary switch reboots, the primary management module continues to operate without interruption. Meanwhile the stack has no interim secondary management module as the switch reboots.
- ④ When the rebooted switch comes back up, it assumes the secondary management role within the stack.

Reloading the Secondary Management Module In a Stack of Two

Reloading Switches with Idle Roles

Similar to reloading Network Interface (NI) modules on chassis-based switches such as the OmniSwitch 9700/9800, modules operating in idle status within a stack can be reloaded via the CLI.

Note. Any traffic being passed on the module's Ethernet ports will be interrupted during the reboot. Other modules within the stack will continue to operate without interruption.

To reset a single module operating in idle mode, use the **reload ni** command. Be sure to include the slot number of the idle switch in the command line. For example:

```
-> reload ni 3
```

Only one idle switch can be reloaded at a time. In order to reload multiple idle switches at once, the entire stack must be reloaded using the **reload all** command.

After reloading a switch operating in an idle role, the switch resumes idle status when it comes back up, *despite its saved slot number*. In other words, if an idle switch with a saved slot number of 1 is reloaded, it resumes its previous idle role. Although it has the lowest possible saved slot number, it does not take over the primary management role. In order for this switch to take over the primary role, all switches in the stack must be reloaded.

Note. For more information on reloading all the switches in a stack, refer to [page 3-30](#). For more information on idle status, refer to [page 3-10](#).

Reloading Switches in Pass-Through Mode

Pass-through mode is a state in which a switch has attempted to join a stack but has been denied primary, secondary, and idle status. Because this is essentially an error state, the pass-through condition must be resolved and any modules operating in pass-through mode must be reloaded.

To reload a module operating in pass-through mode, use the **reload pass-through** command. Be sure to include the slot number of the pass-through switch in the command line. For example:

```
-> reload pass-through 1001
```

Note. Before issuing the **reload pass-through** command, be sure to resolve any conditions causing the switch to operate in pass-through mode. Otherwise, the switch is likely to come up again in pass-through mode. For detailed information, including steps used to recover from pass-through, refer to [page 3-11](#).

Reloading All Switches in a Stack

Reloading all switches in the stack is essentially a full reboot of the virtual chassis. This can be useful in restoring a stack's previously configured topology—i.e., the stack's saved slot numbers and management roles. Note, however, that all data flow on the stack is interrupted whenever a full reboot is issued.

To reset all switches in a stack use the **reload all** command. For example:

```
-> reload all
```

Important. Before issuing the **reload all** command, be sure to read the sections below. Understanding topics such as software synchronization and the effects of saved slot information can help users avoid unexpected results following a full stack reboot.

Software Synchronization During a Full Reload

If the checksum value on the stack's non-primary switches differs in any way from the checksum value on the primary switch, the primary switch automatically distributes its system and configuration software to all other switches in the stack whenever a full reload is executed.

During this automatic software synchronization, system and configuration software on the secondary and idle switches is overwritten. Because the primary switch's "last known good" software is propagated to all switches, the synchronization process helps ensure effective redundancy across the stack.

Effects of Saved Slot Number Information on the Reload Process

Depending on the status of saved slot information across the stack, there are different slot numbering and management role scenarios that can occur following a full reboot. For this reason, checking the current stack topology before issuing a full reboot is strongly recommended. To check the current stack topology, use the **show stack topology** command. Refer to the *OmniSwitch CLI Reference Guide* for detailed command information.

Possible saved slot number conditions include:

- All switches have unique saved slot information
- No switches in the stack have saved slot information
- Some switches have saved slot information, others do not
- Two or more switches have duplicate slot information

All Switches Have Unique Saved Slot Information

If a full reload is issued and all switches have unique slot numbers saved to their **boot.slot.cfg** files, the slot numbers will be assigned according to the saved slot information. The primary management role will be given to the switch with the *lowest* saved slot number. The secondary management role will be given to the switch with the *second-lowest* saved slot number. All other switches will be assigned to idle roles.

An illustrated example of this method for assigning slot numbers and management roles is provided on pages [3-20](#) and [3-21](#).

No Switches In the Stack Have Saved Slot Information

If a full reload is issued and no switches in the stack have unique slot numbers, slot numbers will be assigned beginning with the switch with the lowest MAC address. (This can occur if the **boot.slot.cfg** file has been deleted from each switch's /flash directory—e.g., by issuing the **stack clear slot** command for all modules in the stack.)

The switch with the lowest MAC address is assigned slot number 1 and given the primary management role. The switch connected to stacking port A of the primary switch is automatically assigned slot number 2 and given the secondary management role. Stack cabling is then used to determine the dynamic slot numbering of the remaining modules in the stack. The switch immediately adjacent to slot 2 is assigned slot number 3 and given an idle role, etc.

An illustrated example of this method for assigning slot numbers and management roles is provided on pages [3-18](#) and [3-19](#).

Some Switches Have Saved Slot Information, Others Do Not

If only *some* switches in the stack have **boot.slot.cfg** files in their /flash directories, the system software will first read the contents of these files and then dynamically assigns unique slot numbers to any switches that do not have saved slot information. The primary management role will be given to the switch with the *lowest* saved slot number. The secondary management role will be given to the switch with the *second-lowest* saved slot number. All other switches will be assigned to idle roles.

When unique slot numbers are dynamically assigned by the system software, a **boot.slot.cfg** file is automatically generated with the new slot information. Because all switches now have unique saved slot information, any subsequent **reload all** commands issued will cause the stack to come up as described in the section, “[All Switches Have Unique Saved Slot Information](#)” on page [3-30](#).

Two or More Switches Have Duplicate Slot Information

If a full stack reboot is issued and the same slot number is found in the **boot.slot.cfg** file of two or more switches, the switch with the lowest MAC address is allowed to come up and operate normally. Meanwhile, any other switches with the duplicate slot number come up in *pass-through mode*.

Pass-through mode is essentially an error state in which a switch has been denied primary, secondary, and idle roles within the stack. When a switch is in pass-through mode, its Ethernet ports are brought down and cannot pass traffic. It is for this reason that users should always check the current saved slot number for each switch before issuing the **reload all** command. To check the current saved slot information across the stack, use the **show stack topology** command. For detailed information on pass-through mode, refer to “[Pass-Through Mode](#)” on page [3-11](#).

Avoiding Split Stacks

The term “splitting” a stack refers to the creation of isolated modules within the virtual chassis. A split stack can result from the following conditions:

- Two or more *non-adjacent* switches are reloaded simultaneously
- The stack is reloaded without a redundant stacking cable connection

The sections below offer simple guidelines for avoiding splitting the stack during the reload process.

Do Not Reload Non-Adjacent Switches Simultaneously

If non-adjacent switches in the stack—for example, the top switch in the stack and the third-from-top switch in the stack—are reloaded *simultaneously*, a problem will occur. The switch between the two non-adjacent switches will become isolated and the virtual chassis will be effectively split.

To avoid splitting the stack, do not reload the two non-adjacent switches simultaneously. Instead, simply reload the top switch first, then reload the third-from-top switch, or vice-versa.

Be Sure a Redundant Stacking Cable is Installed at All Times

Another important guideline for avoiding split stacks involves the redundant stacking cable. In order to avoid isolated modules within the virtual chassis, simply make sure that a redundant stacking cable connection exists between the top-most and bottom-most switches at all times.

For more information on the redundant stacking cable connection, refer to [page 3-16](#).

Changing the Secondary Module to Primary

OmniSwitch 6800 Series stacks allow users to manually force the secondary switch to assume the primary management role. This is referred to as “takeover.” The behavior of a takeover is similar to that of reloading the primary management module (see [page 3-25](#)).

Whenever a takeover is initiated, the switch with the secondary role automatically takes over primary management functions. The primary switch is automatically reloaded and any traffic being passed on the primary switch’s Ethernet ports is interrupted.

Meanwhile, the idle switch with the next-lowest slot number automatically assumes the secondary role. When the former primary module comes back up, it assumes an idle role within the stack.

To initiate a takeover sequence, use the **takeover** command. For example:

```
-> takeover
```

Note. Before using the **takeover** command, verify that the switches in the stack are synchronized. Otherwise, data flow and switch management functions may be interrupted due to incorrect or outdated software when a switch takes over the primary management role. For more information, refer to “[Synchronizing Switches in a Stack](#)” on [page 3-35](#).”

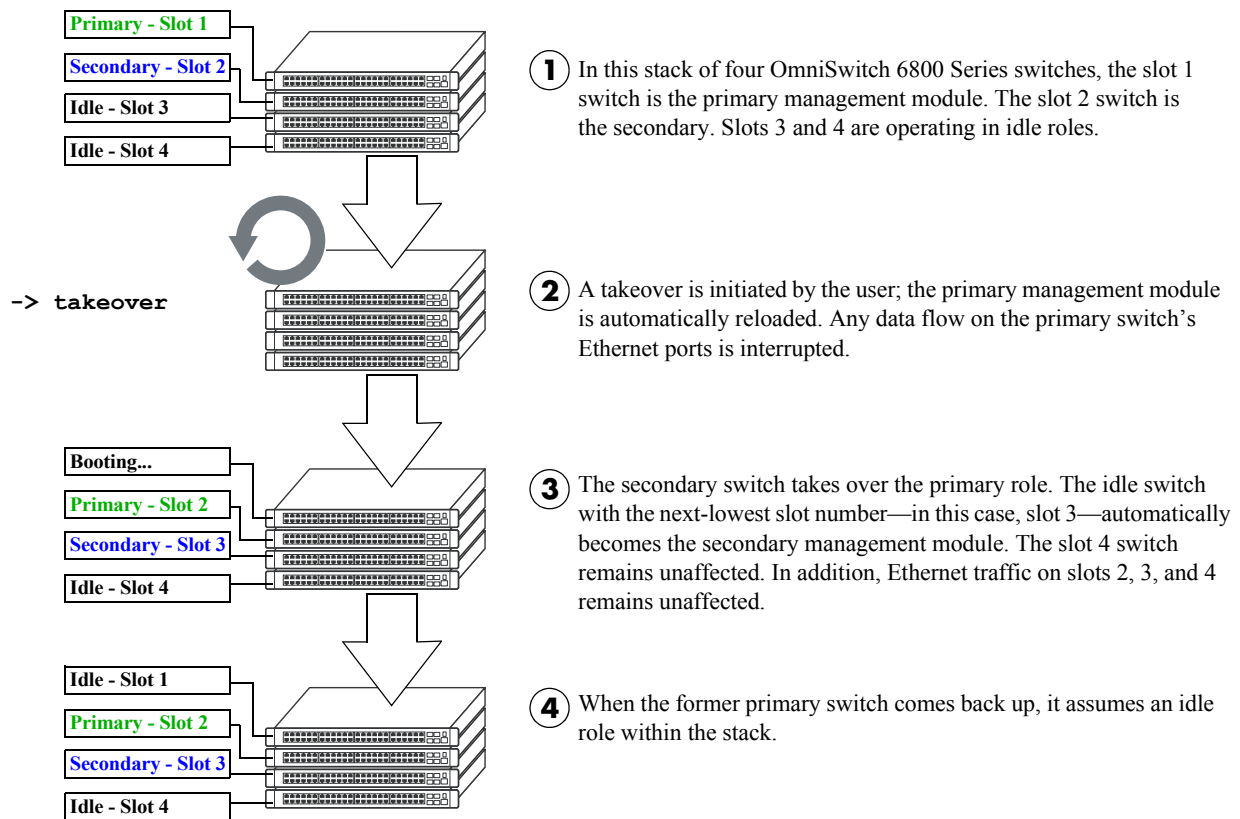

Takeover Behavior In a Stack of Three or More

If there are only two switches in the stack, the former primary switch resumes the secondary role when it comes back up following the takeover.

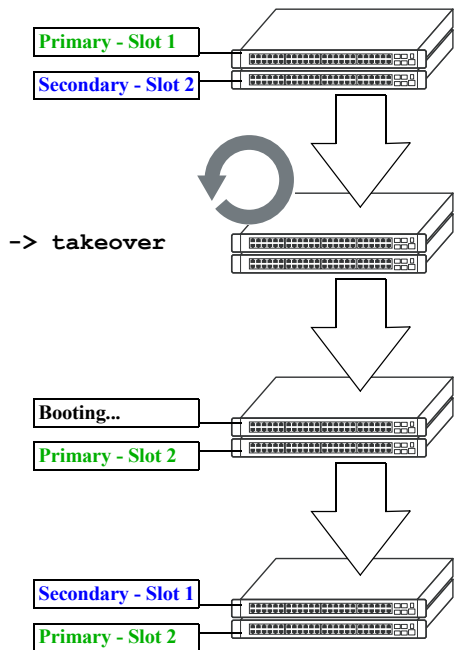

- ① In this stack of two OmniSwitch 6800 Series switches, the slot 1 switch is the primary management module. The slot 2 switch is the secondary.
- ② A takeover is initiated by the user; the primary management module is automatically reloaded. Any data flow on the primary switch's Ethernet ports is interrupted.
- ③ The secondary switch takes over the primary role. Ethernet traffic on slot 2 remains unaffected. Meanwhile the stack has no interim secondary management module as the switch reboots.
- ④ When the former primary switch comes back up, it assumes the secondary management role within the stack.

Takeover Behavior In a Stack of Two

Synchronizing Switches in a Stack

Management module synchronization refers to the process of copying all files in the /flash/working and /flash/certified directories of the primary management module to the /flash/working and /flash/certified directories of all the other switches in the stack. The system and configuration software on the non-primary switches—i.e., the secondary management module and any modules operating in idle—is overwritten.

The synchronization process ensures that the contents of these directories match exactly for all switches across the stack. This can be especially useful after new software has been loaded to the primary management module. Further, synchronization prevents any switch from assuming a management role within the stack with incorrect or outdated software or configuration files. Because the primary switch's "last known good" software is propagated to all switches, the synchronization process helps ensure effective redundancy across the stack.

In order to maintain effective management module redundancy, switches in the stack must be synchronized at all times. To determine whether a stack is in need of synchronization, use the [show running-directory](#) command. For example:

```
-> show running-configuration

CONFIGURATION STATUS
  Running CMM           : PRIMARY,
  CMM Mode              : DUAL CMMs,
  Current CMM Slot     : 1,
  Running configuration : WORKING,
  Certify/Restore Status : CERTIFY NEEDED
SYNCHRONIZATION STATUS
  Flash Between CMMs   : NOT SYNCHRONIZED,
  Running Configuration : NOT AVAILABLE,
  Stacks Reload on Takeover: PRIMARY ONLY
```

This example shows a switch on which the /flash directories between the management modules are not synchronized. To manually synchronize all switches in the stack, enter the following command:

```
-> copy working certified flash-syncro
```

When the synchronization process is initiated, modules within the stack continue to operate without interruption and data flow across the stack is unaffected.

Automatic Synchronization During a Full Reload

If the checksum value on the stack's non-primary switches differs in any way from the checksum value on the primary switch, the primary switch automatically distributes its system and configuration software to all other switches in the stack whenever a full reload is executed.

For more information on initiating a full reload, see [“Reloading All Switches in a Stack” on page 3-30](#).

Note. For more information on management module synchronization and managing the /flash/working and /flash/certified directories, refer to the “Managing CMM Directory Content” chapter in the *Switch Management Guide*.

Monitoring the Stack

As shown in the previous sections, monitoring the current status and operation of all elements in a stack can help users avoid unexpected stack conditions. The table below includes CLI commands that are useful in monitoring stack conditions.

CLI Commands Used for Monitoring a Stack	
show stack topology	Displays the current operating topology of switches within a stack.
show stack status	Displays the current redundant stacking cable status and token availability for a stacked configuration.
show running-directory	Displays the directory from where the switch was booted. This command also shows important information, including whether the software across the stack is synchronized.
show chassis	Displays basic configuration and status information for the switch chassis.
show cmm	Displays basic hardware and status information for primary and secondary management modules operating in the stack.
show ni	Displays basic hardware and status information for modules currently operating in the stack.
show module	Displays basic information for modules installed in the stack. Modules include primary and secondary management modules and any modules operating in idle status.
show module long	Displays detailed information for modules installed in the stack. Modules include primary and secondary management modules and any modules operating in idle status.
show module status	Displays basic status information for modules installed in the stack. Modules include primary and secondary management modules and any modules operating in idle status.
show power	Displays hardware information and current status for chassis power supplies. This includes the status of backup power supplies, if applicable.
show fan	Displays the current operating status of each of the six fans operating in each chassis.
show temperature	Displays the current operating chassis ambient temperature, as well as current temperature threshold settings for each of the modules in the stack.

Visually Monitoring the Stack

Users can also monitor many stack operations by viewing the front panel LEDs on all elements in the stack. Refer to [“Status LEDs” on page 2-13](#) for detailed information on LEDs and stack status.

CLI Commands Supported on Both Primary and Secondary Management Modules

Although most CLI commands are executed when logged into the switch with the primary management role, there is a group of commands that is supported when logged in to either the primary or secondary management module. For a list of these commands, refer to the tables below.

Note. For detailed information on these commands, including command syntax options and definitions, refer to the *OmniSwitch CLI Reference Guide*.

CMM Commands

reload takeover install	debug chassis auto-reboot show running-directory show reload	show microcode
-------------------------------	--	----------------

Chassis Management and Monitoring Commands

show system show hardware info show chassis	show module show module long show module status	show cmm show ni
---	---	---------------------

File Management Commands

cd pwd mkdir rmdir ls dir rename rm	delete cp mv move chmod attrib fsck newfs	ed vi view tty show tty rz more install
--	--	--

Switch Logging and Monitoring Commands

swlog swlog appid level swlog output show log swlog show swlog	debug ktrace debug ktrace appid level debug ktrace show debug systrace debug systrace appid level	debug systrace show debug systrace show log debug memory monitor debug memory monitor show log
--	---	---

Memory Monitoring Commands

show log pmd

A Regulatory Compliance and Safety Information

This appendix provides information on regulatory agency compliance and safety for the OmniSwitch 6800 Series.

Declaration of Conformity: CE Mark

This equipment is in compliance with the essential requirements and other provisions of Directive 73/23/EEC and 89/336/EEC as amended by Directive 93/68/EEC.

Français: Ce matériel est conformément aux conditions essentielles et à d'autres dispositions de 73/23/EEC et de 89/336/EEC directifs comme modifié par Directive 93/68/EEC.

Deutsch: Diese Ausrüstung ist gemäß den wesentlichen Anforderungen und anderen Bestimmungen richtungweisenden 73/23/EEC und des 89/336/EEC, wie von Directive 93/68/EEC geändert.

Español: Este directivo equipo está en conformidad con los requisitos esenciales y otras provisiones 73/23/EEC y 89/336/EEC según la enmienda prevista por Directive 93/68/EEC.

Waste Electrical and Electronic Equipment (WEEE) Statement

The product at end of life is subject to separate collection and treatment in the EU Member States, Norway and Switzerland and therefore marked with the symbol:

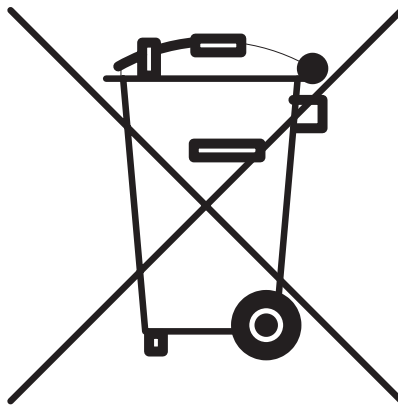

Treatment applied at end of life of the product in these countries shall comply with the applicable national laws implementing directive 2002/96EC on waste electrical and electronic equipment (WEEE).

China RoHS: Hazardous Substance Table

产品说明书附件

SUPPLEMENT TO PRODUCT INSTRUCTIONS

这个文件涉及的是在中华人民共和国境内进口或销售的电子信息产品
Include this document with all Electronic Information Products imported
or sold in the People's Republic of China

部件名称 (Parts)	有毒有害物质或元素 (Hazardous Substance)					
	铅 (Pb)	汞 (Hg)	镉 (Cd)	六价铬 (Cr ⁶⁺)	多溴联苯 (PBB)	多溴二苯醚 (PBDE)
电路模块 (Circuit Modules)	×	○	○	○	○	○
电缆及电缆组件 (Cables & Cable Assemblies)	×	○	○	○	○	○
金属部件 (Metal Parts)	×	○	○	○	○	○
塑料和聚合物部件 (Plastic and Polymeric parts)	○	○	○	○	○	○
对于交付时集成了电池的电子信息产品 For electronic information products delivered with integrated functional batteries:						
电池 (Batteries)	○	○	○	○	○	○
<p>○： 表示该有毒有害物质在该部件所有均质材料中的含量均在 SJ/T11363-2006 标准规定的限量要求以下。 Indicates that the concentration of the hazardous substance in all homogeneous materials in the parts is below the relevant threshold of the SJ/T11363-2006 standard.</p> <p>×： 表示该有毒有害物质至少在该部件的某一均质材料中的含量超出SJ/T11363-2006标准规定的限量要求。 Indicates that the concentration of the hazardous substance of at least one of all homogeneous materials in the parts is above the relevant threshold of the SJ/T11363-2006 standard.</p> <p>对销售之日的所售产品, 本表显示, 阿尔卡特朗讯公司供应链的电子信息产品可能包含这些物质。注意: 在所售产品中可能会也可能不会含有所有所列的部件。</p> <p>This table shows where these substances may be found in the supply chain of Alcatel-Lucent electronic information products, as of the date of sale of the enclosed product. Note that some of the component types listed above may or may not be a part of the enclosed product.</p>						

除非另外特别的标注, 此标志为针对所涉及产品的环保使用期标志。某些零部件会有一个不同的环保使用期(例如, 电池单元模块)贴在其产品上。

此环保使用期限只适用于产品是在产品手册中所规定的条件下工作。

The Environment-Friendly Use Period (EFUP) for all enclosed products and their parts are per the symbol shown here, unless otherwise marked. Certain parts may have a different EFUP (for example, battery modules) and so are marked to reflect such. The Environment-Friendly Use Period is valid only when the product is operated under the conditions defined in the product manual.



Products are packaged using one or more of the following packaging materials:

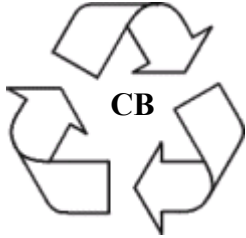

Corrugated Cardboard

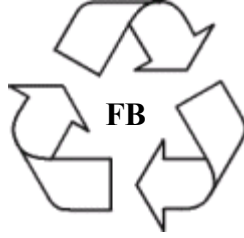

Corrugated Fiberboard



Low-Density Polyethylene

Standards Compliance

The product bears the CE mark. In addition it is in compliance with the following other safety and EMC standards:

Safety Standards

- UL 60950
- CAN/CSA-C22.2 No. 60950-00
- EN 60950
- IEC 60950
- TS 001
- AS/NZS 3260
- CB Certification PBR IEC 950

EMC Standards

- FCC Part 15 (CFR 47) Class A/Class B
- ICES-003 Class A/Class B
- EN 55022 Class A/Class B
- CISPR 22 Class A/Class B
- AS/NZS 3548 Class A/Class B
- VCCI Class A/Class B
- EN 55024
- EN 50082-1
- EN 61000-3-2
- EN 61000-3-3
- EN 61000-4-2
- EN 61000-4-3
- EN 61000-4-4
- EN 61000-4-5
- EN 61000-4-6
- EN 61000-4-8
- EN 1000-4-11

Safety and Environmental Standards

- ETS 300 019 Storage Class 1.1
- ETS 300 019 Transportation Class 2.3
- ETS 300 019 Stationary Use Class 3.1

stand-alone OmniSwitch 6800 Series switches comply with Class A and Class B standards for digital devices per the FCC Part 15, ICES-003, EN 55022, CISPR 22, AS/NZS 3548, and VCCI standards. Modules with copper connectors meet Class A requirements using unshielded (UTP) cables, but meet Class B requirements using shielded (STP) cables.

Stacks consisting of two to eight OmniSwitch 6800 Series switches comply with Class A requirements.

FCC Class A, Part 15

This equipment has been tested and found to comply with the limits for Class A digital device pursuant to Part 15 of the FCC Rules. These limits are designed to provide reasonable protection against harmful interference when the equipment is operated in a commercial environment. This equipment generates, uses, and can radiate radio frequency energy and, if not installed and used in accordance with the instructions in this guide, may cause interference to radio communications. Operation of this equipment in a residential area is likely to cause interference, in which case the user will be required to correct the interference at his own expense.

The user is cautioned that changes and modifications made to the equipment without approval of the manufacturer could void the user's authority to operate this equipment. It is suggested that the user use only shielded and grounded cables to ensure compliance with FCC Rules.

If this equipment does cause interference to radio or television reception, the user is encouraged to try to correct the interference by one or more of the following measures:

- Reorient the receiving antenna.
- Relocate the equipment with respect to the receiver.
- Move the equipment away from the receiver.
- Plug the equipment into a different outlet so that equipment and receiver are on different branch circuits.

If necessary, the user should consult the dealer or an experienced radio/television technician for additional suggestions.

Canada Class A Statement

This equipment does not exceed Class A limits per radio noise emissions for digital apparatus, set out in the Radio Interference Regulation of the Canadian Department of Communications.

Avis de conformité aux normes du ministère des Communications du Canada

Cet équipement ne dépasse pas les limites de Classe A d'émission de bruits radioélectriques pour les appareils numériques, telles que prescrites par le Règlement sur le brouillage radioélectrique établi par le ministère des Communications du Canada.

JATE

This equipment meets the requirements of the Japan Approvals Institute of Telecommunications Equipment (JATE).

CISPR22 Class A warning

This is a Class A product. In a domestic environment, this product may cause radio interference. Under such circumstances, the user may be requested to take appropriate countermeasures.

VCCI

This is a Class A product based on the standard of the Voluntary Control Council for Interference by Information Technology Equipment (VCCI). If this equipment is used in a domestic environment, radio disturbance may arise. When such trouble occurs, the user may be required to take corrective actions.

この装置は、情報処理装置等電波障害自主規制協議会（VCCI）の基準に基づくクラスA情報技術装置です。この装置を家庭環境で使用すると電波妨害を引き起こすことがあります。この場合には使用者が適切な対策を講ずるよう要求されることがあります。

Class A Warning for Taiwan and Other Chinese Markets

This is a Class A Information Product. When used in a residential environment, it may cause radio frequency interference. Under such circumstances, the user may be requested to take appropriate counter-measure.

警告使用者：
這是甲類的資訊產品，在居住的環境中使用時，可能會造成射頻干擾，在這種情況下，使用者會被要求採取某些適當的對策。

Translated Safety Warnings

Chassis Lifting Warning

Two people are required when lifting the chassis. Due to its weight, lifting the chassis unassisted can cause personal injury. Also be sure to bend your knees and keep your back straight when assisting with the lifting of the chassis.

Français: Le châssis doit être soulevé par deux personnes au minimum. Pour éviter tout risque d'accident, maintenez le dos droit et poussez sur vos jambes. Ne soulevez pas l'unité avec votre dos.

Deutsch: Zum Anheben des Chassis werden zwei Personen benötigt. Aufgrund des Gewichts kann das Anheben ohne Unterstützung zu Personenschäden führen. Heben Sie das Chassis aus den Knien und halten Sie den Rücken gerade wenn Sie beim Anheben des Chassis assistieren.

Español: Se requieren dos personas para elevar el chasis. Para evitar lesiones, mantenga su espalda en posición recta y levante con sus piernas, no con su espalda.

Blank Panels Warning

Because they regulate airflow and help protect internal chassis components, blank cover plates should remain installed at empty module slots and power supply bays at all times.

Français: Les caches blancs remplissent trois fonctions importantes : ils évitent tout risque de choc électrique à l'intérieur du châssis, ils font barrage aux interférences électromagnétiques susceptibles d'altérer le fonctionnement des autres équipements et ils dirigent le flux d'air de refroidissement dans le châssis. Il est vivement recommandé de vérifier que tous les caches, modules d'alimentation et plaques de protection sont en place avant d'utiliser le système.

Deutsch: Die leeren Modulblenden schützen interne Komponenten und leiten den Luftstrom. Deshalb müssen in allen unbelegten Slots die Modulblenden immer installiert bleiben.

Español: Las tapaderas blancas regulan la circulación de aire y ayudan a proteger componentes internos del chasis y siempre deben estar instaladas en las ranuras vacías del chasis y fuentes de alimentación.

Electrical Storm Warning

To avoid a shock hazard, do not connect or disconnect any cables or perform installation, maintenance, or reconfiguration of this product during an electrical storm.

Français: Ne pas travailler sur le système ni brancher ou débrancher les câbles pendant un orage.

Deutsch: Um elektrische Schläge zu vermeiden dürfen während eines Gewitters and diesem Gerät keine Kabel angeschlossen oder gelöst werden, sowie keinerlei Installationen, Wartungen oder Konfigurationen vorgenommen werden.

Español: Para evitar peligro de descargas, no conecte o desconecte ningún cable, ni realice ninguna instalación, mantenimiento o reconfiguración de este producto durante una tormenta eléctrica.

Installation Warning

Only personnel knowledgeable in basic electrical and mechanical procedures should install or maintain this equipment.

Français: Toute installation ou remplacement de l'appareil doit être réalisée par du personnel qualifié et compétent.

Deutsch: Dieses Gerät soll nur von Personal installiert oder gewartet werden, welches in elektrischen und mechanischen Grundlagen ausgebildet ist.

Español: Estos equipos deben ser instalados y atendidos exclusivamente por personal adecuadamente formado y capacitado en técnicas eléctricas y mecánicas.

Invisible Laser Radiation Warning

Lasers emit invisible radiation from the aperture opening when no fiber-optic cable is connected. When removing cables do not stare into the open apertures. In addition, install protective aperture covers to fiber ports with no cable connected.

Français: Des radiations invisibles à l'œil nu pouvant traverser l'ouverture du port lorsque aucun câble en fibre optique n'y est connecté, il est recommandé de ne pas regarder fixement l'intérieur de ces ouvertures. Installez les caches connecteurs prévus à cet effet.

Deutsch: Die Laser strahlen an der Blendenöffnung unsichtbares Licht ab, wenn keine Glasfaserkabel angeschlossen sind. Blicken Sie nicht in die Öffnungen und installieren Sie unverzüglich die Abdeckungen über den Glasfaseranschlüssen.

Español: Debido a que la apertura del puerto puede emitir radiación invisible cuando no hay un cable de fibra conectado, procurar no mirar directamente a las aperturas para no exponerse a la radiación.

Lithium Battery Warning

There is a danger of explosion if the Lithium battery in your chassis is incorrectly replaced. Replace the battery only with the same or equivalent type of battery recommended by the manufacturer. Dispose of used batteries according to the manufacturer's instructions. The manufacturer's instructions are as follows: Return the module with the Lithium battery to Alcatel-Lucent. The Lithium battery will be replaced at Alcatel-Lucent's factory.

Français: Il y a un danger d'explosion si la batterie de lithium dans votre châssis est remplacée avec une autre ne correspondant pas aux préconisations constructeur. Il faut donc renvoyer le module en réparation chez Alcatel-Lucent qui se chargera de remplacer la batterie.

Deutsch: Es gibt eine Gefahr der Explosion, wenn die Lithiumbatterie in Ihrem Chassis falsch ersetzt wird. Ersetzen Sie die Batterie nur mit gleichen oder dem gleichwertigen Typen der Batterie empfohlen durch den Hersteller. Entledigen Sie sich benutzte Batterien entsprechend den Anweisungen des Herstellers. Die Anweisungen des Herstellers sind, wie folgt: Bringen Sie das Modul mit der Lithiumbatterie zu Alcatel-Lucent zurück. Die Lithiumbatterie wird an der Fabrik Alcatel-Lucent's ersetzt.

Español: Si substituye las pilas de litio en su chasis, siempre utilice el mismo modelo o el tipo equivalente de pila recomendada por el fabricante. Deshágase de las pilas usadas según las instrucciones del fabricante. Devuelva el módulo con la pila de litio a Alcatel-Lucent. La pila de litio será substituida en la fábrica de Alcatel-Lucent.

Dansk: ADVARSEL! Lithiumbatteri--Eksplodingsfare ved fejlagtig handling. Udskiftning ma kun ske batteri af samme fabrikat og type. Lever det brugte batteri tilbage tilleverandoren.

Operating Voltage Warning

To reduce the risk of electrical shock, keep your hands and fingers out of power supply bays and do not touch the backplane while the switch is operating.

Français: Pour réduire tout risque électrique, gardez vos mains et doigts hors des alimentations et ne touchez pas au fond de panier pendant que le commutateur fonctionne.

Deutsch: Um die Gefahr des elektrischen Schlages zu verringern, halten Sie Ihre Hände und Finger aus Spg. Versorgungsteilbuchten heraus und berühren Sie nicht die Rückwandplatine während der Schalter steuert.

Español: Para reducir el riesgo de descargas eléctricas, no meta sus manos y dedos dentro del chasis de la fuente de alimentación y no toque componentes internos mientras que el interruptor está conectado.

Power Disconnection Warning

Your switch is equipped with multiple power supplies. To reduce the risk of electrical shock, be sure to disconnect all power connections before servicing or moving the unit.

Français: Il se peut que cette unité soit équipée de plusieurs raccordements d'alimentation. Pour supprimer tout courant électrique de l'unité, tous les cordons d'alimentation doivent être débranchés.

Deutsch: Ihr Schalter wird mit mehrfachen Spg.Versorgungsteilen ausgerüstet. Um die Gefahr des elektrischen Schlages zu verringern, seien Sie sicher alle Stromanschlüsse zu trennen bevor Sie die Maßeinheit instandhalten oder verschieben.

Español: Antes de empezar a trabajar con un sistema, asegurese que el interruptor está cerrado y el cable eléctrico desconectado.

Proper Earthing Requirement Warning

To avoid shock hazard:

- The power cord must be connected to a properly wired and earth receptacle.
- Any equipment to which this product will attached must also be connected to properly wired receptacles.

Français: Pour éviter tout risque de choc électrique:

- Ne jamais rendre inopérant le conducteur de masse ni utiliser l'équipement sans un conducteur de masse adéquatement installé.
- En cas de doute sur la mise à la masse appropriée disponible, s'adresser à l'organisme responsable de la sécurité électrique ou à un électricien.

Deutsch: Aus Sicherheitsgründen:

- darf das Netzkabel nur an eine Schutzkontaktsteckdose angeschlossen werden.
- dürfen für den Anschluß anderer Geräte an den Drucker auch nur Schutzkontaktsteckdosen verwendet werden.

Español: Para evitar peligro de descargas:

- Para evitar peligro de descargas asegurese de que el cable de alimentación está conectado a una toma de alimentación adecuadamente cableada y con toma de tierra.
- Cualquier otro equipo a cual se conecte este producto también debe estar conectado a tomas de alimentación adecuadamente cableadas.

Read Important Safety Information Warning

The *Getting Started Guide* that accompanied this equipment contains important safety information about which you should be aware when working with hardware components in this system. You should read this guide before installing, using, or servicing this equipment.

Français: Avant de brancher le système sur la source d'alimentation, consultez les directives d'installation disponibles dans le "Getting Started Guide".

Deutsch: Die *Getting Started Guide*, die diese Ausrüstung begleitete, enthält wichtige Sicherheit Informationen, über die Sie beim Arbeiten bewußt sein sollten mit Hardwareeinheiten in diesem System. Sie sollten diese Anleitung lesen, bevor Sie installieren, verwenden, oder instandhalten diese Ausrüstung.

Español: La 'Getting Started Guide' que acompañó este equipo contiene información importante de seguridad sobre la cual usted debe estar enterado al trabajar con los componentes de dotación física en este sistema. Usted debe leer esta guía antes de instalar, usar o mantener este equipo.

Restricted Access Location Warning

This equipment should be installed in a location that restricts access. A restricted access location is one where access is secure and limited to service personnel who have a special key, or other means of security.

Français: Le matériel doit être installé dans un local avec accès limité ou seules les personnes habilitées peuvent entrer.

Deutsch: Diese Ausrüstung sollte in einen Standort installiert werden, der Zugriff einschränkt. Ein eingeschränkter Zugriff Standort ist einer, wo Zugriff befestigen und an Service-Personal, das eine spezielle Taste haben, oder an andere Mittel der Sicherheit begrenzt ist.

Español: Este equipo se debe instalar en un sitio con acceso restringido. Un sitio con el acceso restringido es uno seguro y con acceso limitado al personal de servicio que tiene una clave especial u otros medios de seguridad.

Wrist Strap Warning

Because electrostatic discharge (ESD) can damage switch components, you must ground yourself properly before continuing with the hardware installation. For this purpose, Alcatel-Lucent provides a grounding wrist strap and a grounding lug located near the top-right of the chassis. For the grounding wrist strap to be effective in eliminating ESD, the power supplies must be installed in the chassis and plugged into grounded AC outlets.

Français: L'électricité statique (ESD) peut endommager les composants du commutateur. Pour cette raison Alcatel-Lucent joint à l'envoi du châssis un bracelet antistatique à brancher sur la prise mise à la terre située en bas à droite du commutateur. Vous devrez mettre ce bracelet avant toute intervention hardware.

Deutsch: Weil elektrostatische Entladung (ESD) Schalterbestandteile beschädigen kann, müssen Sie richtig sich reiben, bevor Sie mit der Hardwareinstallation fortfahren. Zu diesem Zweck stellt Alcatel-Lucent eine erdenhandgelenkbrücke und eine Erdungsöse zur Verfügung, die nahe dem Oberseite-rechten des Chassis gelegen sind. Damit die erdenhandgelenkbrücke wirkungsvoll ist, wenn man ESD beseitigt, die Spg. Versorgungsteile muß in das Chassis installiert werden und eingesteckt werden in geerdete Wechselstrom Anschlüsse.

Español: La descarga electrostática (ESD) puede dañar componentes electrónicos. Usted debe asegurarse que está en contacto con tierra antes de hacer la instalación del equipo. Con este fin, Alcatel-Lucent proporciona una pulsera de muñeca para conectar al chasis en la toma de tierra situada en la parte superior derecha del chasis. Para que la correa de muñeca sea eficaz en la eliminación de ESD, las fuentes de alimentación deben estar instaladas en el chasis y conectadas a enchufes CA con tierra adecuada.

Instrucciones de seguridad en español

Advertencia sobre el levantamiento del chasis

Se requieren dos personas para levantar el chasis. Debido a su peso, la elevación del chasis sin ayuda puede causar daños corporales. También es seguro doblar sus rodillas y guardar su espalda derecho al ayudar a levantar el chasis.

Advertencia de las tapaderas en blanco

Porque regulan la circulación de aire y ayudan a proteger componentes internos del chasis, las tapaderas en blanco deben seguir instaladas en las ranuras vacías del módulo y la fuente de alimentación siempre.

Advertencia en caso de tormenta eléctrica

Para evitar peligro de descargas, no conecte o desconecte ningún cable, ni realice ninguna instalación, mantenimiento o reconfiguración de este producto durante una tormenta eléctrica.

Advertencia de instalación

Solamente el personal bien informado en procedimientos eléctricos y mecánicos básicos debe instalar o mantener este equipo.

Advertencia de radiación láser invisible

Los lasers emiten radiación invisible de la apertura abierta cuando no se conecta ningún cable de fibra óptica. Al quitar los cables no mire fijamente en las aberturas abiertas. Además, instale las cubiertas protectoras de la apertura a las salidas de la fibra sin el cable conectado.

Advertencia de la batería de litio

Hay un peligro de la explosión si la batería del litio en su chasis se substituye incorrectamente. Substituya la batería solamente por el mismo o el equivalente de tipo de batería recomendado por el fabricante. Deseche las baterías usadas según las instrucciones del fabricante. Las instrucciones del fabricante son como sigue: Devuelva el módulo con la batería del litio a Alcatel-Lucent. La batería del litio será substituida en la fábrica de Alcatel-Lucent.

Advertencia sobre la tensión de operación

Para reducir el riesgo del choque eléctrico, mantenga sus manos y dedos fuera de la fuente de alimentación y no toque la placa madre mientras que el interruptor está funcionando.

Advertencia sobre la desconexión de la fuente

Su interruptor esta equipado por fuentes de alimentación múltiples. Para reducir el riesgo de choque eléctrico, asegúrese desconectar todas las conexiones de alimentación antes de mantener o de mover la unidad.

Advertencia sobre una apropiada conexión a tierra

Para evitar peligro de descargas:

- El cable de alimentación debe estar conectado a una toma de alimentación adecuadamente cableada y con toma de tierra.

Cualquier equipo al cual se conecte este producto debe estar también conectado a tomas de alimentación adecuadamente cableadas.

Leer “información importante de seguridad”

La *Guía de “Comenzando a Usar”* que acompaña este equipo contiene información importante de seguridad sobre la cual usted debe saber al trabajar con los componentes de dotación física en este sistema. Usted debe leer esta guía antes de instalar, de usar, o de mantener este equipo.

Advertencia de acceso restringido

Este equipo se debe instalar en una ubicación que restrinja el acceso. Una ubicación con acceso restringido es una donde está seguro y limitado el acceso al personal de servicio que tiene un clave especial, u otros medios de la seguridad.

Advertencia de pulsera antiestática

Debido a que la descarga electrostática (ESD) puede dañar componentes del interruptor, usted debe conectarse a tierra correctamente antes de continuar con la instalación del equipo. Para este propósito, Alcatel-Lucent proporciona una pulsera antiestática y un terminal que pone a tierra situados cerca de la parte superior derecha del chasis. Para que la pulsera antiestática sea eficaz en la eliminación de ESD, las fuentes de alimentación se deben instalar en el chasis y enchufar en las salidas de CA con descarga a tierra.

Clase de seguridad

Cumple con 21CFR 1040.10 y 1040.11 ó sus equivalentes.

Index

Numerics

- 10 Gigabit expansion module 2-34
 - technical specifications 2-34
 - tokens 2-35

A

- availability 1-4
 - hardware monitoring 1-6, 3-36
 - hot swapping 1-5
 - management module redundancy 1-4
 - software rollback 1-5

B

- backup power shelf 2-40
 - rack-mounting 2-44
 - specifications 2-41
- backup power supply 2-42
 - daughtercard 2-48
 - hot swapping 2-46
 - installing 2-46
 - powering on 2-48
 - removing 2-49
 - specifications 2-43
- backup power supply daughtercard 2-48
 - installing 2-48
 - removing 2-51
- blank cover panels 2-18
- bridge port 10gig os8800optimized** command 2-36

C

- chassis
 - airflow 2-16, 2-17
 - booting 2-25
 - installing 2-16
 - monitoring 2-31
 - OS6800-24 front panel 2-3
 - OS6800-24L front panel 2-9
 - OS6800-48 front panel 2-5
 - OS6800-48L front panel 2-11
 - OS6800-U24 front panel 2-7
 - rack-mounting 2-20
 - rear panel 2-15
 - tabletop 2-19
- chassis types
 - OS6800-24 2-3
 - OS6800-24L 2-9
 - OS6800-48 2-5
 - OS6800-48L 2-11
 - OS6800-U24 2-7

- CLI commands
 - supported on secondary switch 3-37
- console port 2-28, 2-30
 - default settings 2-28
 - modifying default settings 2-28

F

- fabric capacities 1-7

H

- hardware monitoring 1-6, 2-31, 3-36
 - automatic 1-6
 - LEDs 1-6, 2-13, 2-26, 2-33
 - user-driven 1-6
- hot swapping 1-5, 2-46, 3-22
 - modules in a stack 3-22

I

- idle modules 3-10
 - reloading 3-29
- image rollback
 - see* software rollback

L

- LEDs
 - see* hardware monitoring

M

- management module redundancy 1-4
- management roles
 - changing the secondary to primary 3-33
 - commands supported on secondary 3-37
 - reloading a stack 3-30
 - synchronizing primary and secondary 3-35

O

- OmniSwitch 6800 Series
 - application examples 1-8–1-11
 - stacks 1-3
- OmniSwitch 6800-24 2-3
 - technical specifications 2-4
- OmniSwitch 6800-24L 2-9
 - technical specifications 2-10
- OmniSwitch 6800-48 2-5
 - technical specifications 2-6
- OmniSwitch 6800-48L 2-11
 - technical specifications 2-12
- OmniSwitch 6800-U24 2-7
 - technical specifications 2-8
- OS6800-24
 - see* OmniSwitch 6800-24
- OS6800-24L
 - see* OmniSwitch 6800-24L
- OS6800-48
 - see* OmniSwitch 6800-48

OS6800-48L
see OmniSwitch 6800-48L
 OS6800-BPS
see backup power supply
 OS6800-BPS-SHLF
see backup power shelf
 OS6800-U24
see OmniSwitch 6800-U24
 OS6800-XNI-U2
see 10 Gigabit expansion module

P

pass-through modules 3-11
 reloading 3-29
 pinouts 2-30, 2-52
 port capacities 1-7
 power cords 2-27
 primary management module 3-2
 dynamic selection 3-5
 reloading 3-25

R

reload all command 3-29, 3-30
reload command 3-25, 3-27
reload ni command 3-29
reload pass-through command 3-29

S

secondary management module 3-2
 dynamic selection 3-8
 reloading 3-27
show chassis command 2-31
show fan command 2-32
show module command 3-18
show ni command 3-18
show power command 2-53
show spantree ports command 2-36
show stack status command 3-17
show temperature command 2-31
 software rollback 1-5
 software synchronization 3-35
 stacks 1-3, 3-1–3-37
 booting 2-26
 cabling 2-22, 3-15
 idle modules 3-10
 management roles 3-2
 merging 3-23
 monitoring 3-36
 pass-through modules 3-11
 rack-mounting 2-22
 reloading 3-25, 3-30
 setup 2-22
 slot numbering 3-18–3-21
 tokens 2-35, 3-24

T

takeover command 3-33
 technical specifications
 10 Gigabit expansion module 2-34
 backup power shelf 2-41
 backup power supply 2-43
 console port 2-28, 2-30
 OmniSwitch 6800-24 2-4
 OmniSwitch 6800-24L 2-10
 OmniSwitch 6800-48 2-6
 OmniSwitch 6800-48L 2-12
 OmniSwitch 6800-U24 2-8
 pinouts 2-30, 2-52